

# S7020T Terminal Insertion Machine

## Use's Manual



**Thank you for using the products of Shenzhen Southern Machinery Sales And Service Co., Ltd. ! To ensure your safe and effective use of this equipment, please read this manual carefully before use. If you have any questions during the use, please contact our company. Thank you for your cooperation!**

**All rights reserved!**

# Catalog

<b>Catalog.....</b>	<b>2</b>
<b>1. Safety matters.....</b>	<b>3</b>
1.1 handling.....	4
1.2 unpacking.....	5
1.3 basic equipment installation settings .....	5
1.4 main power connection.....	5
1.5 operation safety.....	6
<b>2. Equipment introduction.....</b>	<b>8</b>
2.1 function summary.....	8
2.2 equipment specifications and relevant parameters.....	8
2.3 brief description of equipment movement process.....	9
2.4 equipment operation steps.....	12
<b>3. Operation control procedure.....</b>	<b>14</b>
3.1 introduction to operation program interface .....	14
3.2 Classification details of each function item.....	14
3.3 Camera adjustments.....	26
3.4 Parameter setting.....	29
3.5 Engineer parameters.....	32
<b>4. Panasonic Servo Introduction.....</b>	<b>35</b>
<b>5. Reset of drive and motion card.....</b>	<b>43</b>
<b>6. Servo drive troubleshooting.....</b>	<b>44</b>

<b>7. Maintenance and adjustment and common fault handling.....</b>	<b>44</b>
7.1 Maintenance.....	45
7.2 common faults and handling methods.....	46
7.3 The adjustment method of each action part of the machine...	48
7.4 Introduction of customized terminal insertion machine.....	56
7.5 I/O board and control board and circuit diagram.....	59
<b>8. Introduction to explosion diagram.....</b>	<b>65</b>
8.1 Insertion head part.....	65
8.2 Clinching base part.....	67
8.3 Worktable part.....	69
8.4 Conveyor part.....	72
8.5 Feeding part.....	74

## **1. Safety matters**

**Before contacting the equipment, please read this operation manual carefully and operate it correctly in strict accordance with the requirements. Please operate after receiving training and mastering the knowledge, safety information and precautions of the equipment. Equipment safety signs are as follows:**

**Danger signs**

Indicates a hazardous event. Failure to operate as required may cause damage to the site Serious or even fatal injury caused by personnel.

**Pay attention to signs**

Indicates that improper operation may cause personal injury or equipment damage below moderate level.

**Prohibition sign**

Indicates that the operation is absolutely prohibited.

## 1.1 Handling

**Attention!**

1. Before handling, it is necessary to fix the insertion head, worktable and loading and unloading plate connecting platform.
2. During handling, take care not to have violent impact action, otherwise the machine may be damaged.
3. When handling, please use the handling machinery.

## 1.2 Unpacking

1. Place the machine in a flat and wide place.
2. Open the packaging cover at the upper end of the machine. During this process, do not impact with force, and do not insert the tool too deep. Take care not to drop the upper packing plate.
3. Remove the front and back packing plates.
4. Remove the left and right packing plates.
5. Use a forklift to lift the machine from the middle of the front bottom of the machine.
6. Remove the bottom packing plate when the machine is lifted.
7. After the machine is stably placed in the fixed position, remove the film packaging and the moving part fastening packaging.

## 1.3 Basic equipment installation settings



### **Attention!**

1. Ensure the ground bearing capacity.
2. Make sure that the machine workbench is set in horizontal state, otherwise it will cause machine failure.
3. Do not make the machine suffer strong impact, otherwise it will cause machine failure.
4. Ensure that the power supply is in normal state and avoid electric shock and fire.
5. Ensure the pressure and dryness of the input air, otherwise it may cause instability of insertion work.
6. The machine shall be placed at a distance of more than 0.6m from the wall or other machines, and the operator shall face the front of the machine.
7. Do not use around water, corrosive substances, flammable gases and combustible substances

## 1.4 main power connection

1. The rated voltage of the equipment is single-phase 220V / 50Hz, or other standards will be used according to the user's requirements, so the rated voltage of the machine must be confirmed at the beginning.

2. The ground wire must be grounded.
3. When connecting the cable, do not change the color of the cable.

## 1.5 operation safety



### **Danger!**

**Due to the risk of electric shock or bruise when operating this machine, please pay attention to the following items!**

1. Cut off the power supply when moving the machine, wiring, maintenance and detection, and operate after the indicator light on the operation panel is completely off, otherwise there will be electric shock.
2. There is a risk of electric shock when the surface of the cable falls off, the cable is pulled by excessive external force, and the weight is squeezed.
3. It is forbidden to put all kinds of articles on the machine, otherwise falling into the machine will cause danger.
4. This machine is equipped with light sensor device. Under the condition of detection, do not use the naked eye to watch directly, otherwise there will be the risk of blindness.



### **Attention!**

1. Please be familiar with the operation requirements of the equipment before operating the machine, otherwise the machine will fail due to the operation error.
2. Due to the update of technology and special requirements of the product, part of the physical products may be different from the instructions. Please refer to the physical products, and we will try our best to add additional instructions.
3. Equipment operating environment: temperature: 5-25. C. The relative humidity is 20-95%. It is not exposed to direct sunlight, condensation, splashing water, oil and chemical liquid.
4. The computer configured on this machine can only be used for this machine. It is strictly prohibited to use it for other purposes. It is strictly prohibited to insert other mobile memory with virus into this machine to avoid damaging the control system.
5. The technicians who operate and maintain the machine must be able to use the computer.
6. In case of machine failure, first find out the cause and clear the failure, and then restart the machine after ensuring safety.
7. Maintenance and detection must be carried out in a safe state.

## S7020T Terminal Insertion Machine Use's Manual

8. When replacing parts, be sure to use the specified parts which are consistent with the machine, otherwise the machine may fail.
9. When cutting off the power supply of the device, please perform the system exit / shutdown process in the following order. If you do not perform this process and directly cut off or restart the power supply, the data will not be well saved, and the hard disk may be damaged: exit the application program exit windows cut off the power supply of the device.
10. Restart immediately after power failure, and keep it for 10-20 seconds, otherwise the internal circuit of the machine cannot be fully initialized.
11. For the sake of personal safety, please do not open the front door and back door without taking any safety measures when the equipment is running or standby. It is strictly forbidden to close to the moving parts of the machine, such as clothes, limbs, etc., otherwise, it may cause personal injury.
12. Do not let the equipment suffer from impact or strong vibration, otherwise, it may cause failure.
13. When it is not used for a long time, the power supply and air source must be cut off. If you suspend the use of the equipment, please keep the equipment in the following places:  
the ambient temperature is 0-40. C. Place with relative humidity of 20-95%, free from direct sunlight, condensation, splashing water, oil and chemical liquid. In order to prevent dust, cover measures (such as covering) may be taken, but moisture-proof measures shall be taken.

**prohibited**

1. All cards inside the computer may fail due to static electricity, so do not touch them by hand.
2. It is forbidden to dismantle and repair the servo driver and servo engine. In case of any fault, the manufacturer shall repair it.
3. During the operation of the machine, it is forbidden to contact any moving parts and keep away from the moving space, otherwise there will be a risk of collision.
4. It is forbidden to dismantle or transform the equipment at will, or use it for other purposes.
5. It is forbidden for two people to operate the same equipment at the same time

## 2. Equipment introduction

### 2.1 function summary

2.1.1 the equipment is used to automatically insert switch (key), connector (row insertion), radial tape weaving and other parts on PCB.

2.1.2 vision correction: automatically detect the deviation between PCB hole position coordinate and NC data, and automatically correct to make the insertion positioning accurate.

2.1.3 Automatic width adjustment of the workbench: Automatically adjust the width of the workbench and docking station according to the size entered in the program.

2.1.4 Material code scanning to prevent errors: Scan the QR code or bar of the material before production to prevent the material from being loaded incorrectly.

2.1.5 Insertion force detection: Automatically detect the Insertion force during production to prevent excessive pressure from damaging the material and PCB board.

2.1.6 production data management: automatically generate production statistics such as output, insertion rate and working time.

2.1.7 automatic patching: in case of empty patching caused by wrong feeding, it can be set for 0-2 times.

2.1.8 simple operation interface: running Chinese operation system in Windows environment, all production data, management data and self diagnosis can be completed on the host.

### 2.2 equipment specifications and relevant parameters

project	Specifications			
Insert part object	Tap switch	Connector class (strip)	Copper inserts (iron)	Axial braiding
Packaging method of parts	bulk	bulk	bulk	52mm tape
Theoretical speed	0.6s/point	0.55s/point	0.55s/point	1s/point
Feeding system	bowl feeder, track	bowl feeder, track	bowl feeder, track	Tape feeder
PCB size	Min 80mm × 80mm; max 380mm × 280mm			
Part fixing method	Fixed corner			

## S7020T Terminal Insertion Machine Use's Manual

Control system	intelligent insertion control system (Windows system control platform)
display system	17 inch color LCD
X-Y worktable mobile unit	0.001mm/pulse
Point to point positioning accuracy	0.025mm; repeated positioning accuracy: 0.05mm
Automatic correction accuracy	0.015mm
PCB installation time	3 seconds
Programming functions	Online visual programming, visual correction, Excel format
Special function	Automatic width adjustment, materials QR code scanning, insertion force detection (optional)
Data input	USB, manual entry
communication interface	RS-232C
Noise	70 dB
Power Supply	AC220V ±10V Singel Phase, 50/60HZ, 1.6KVA
power	2.0KW Max
Air Supply	5-6kgf/cm <sup>2</sup>
Compressed air consumption	0.6M <sup>3</sup> /min
Dimension	2160×1330×1530mm
Weight	1500kg

### 2.3 brief description of equipment movement process

**The control system receives / sends signals to each executive part through I / O.**

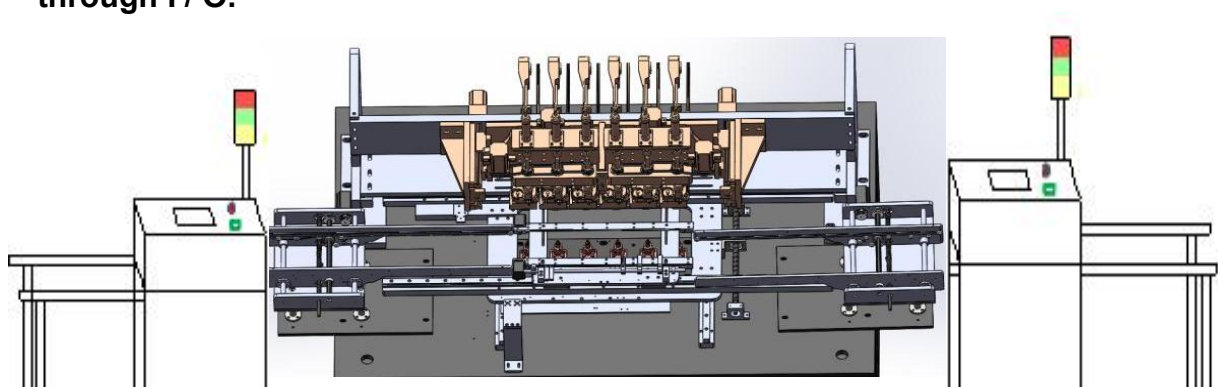

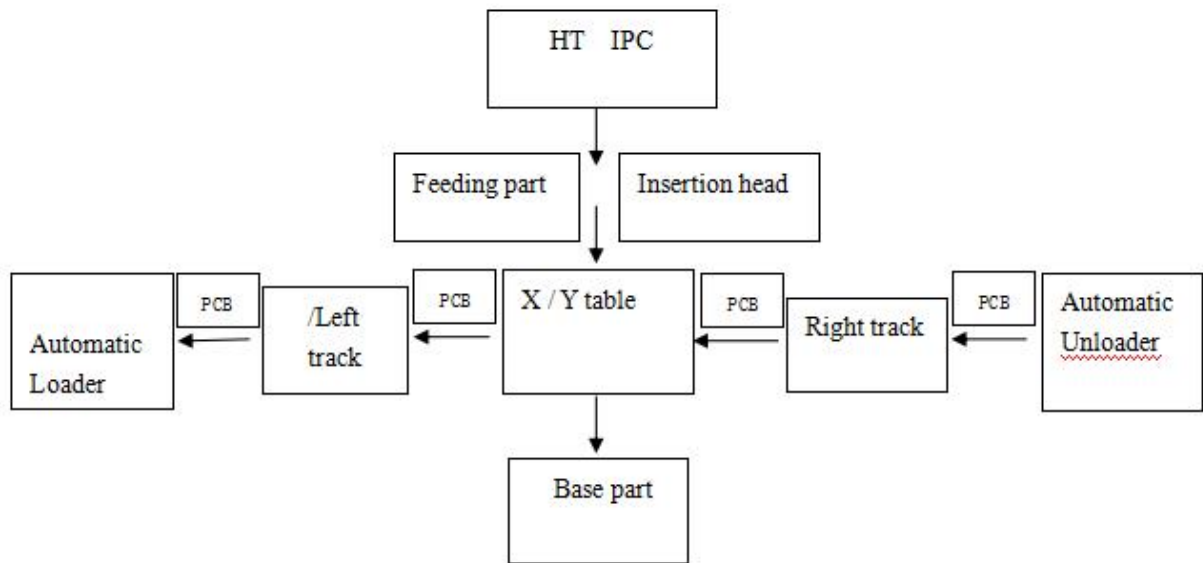

2.3.1 after receiving the board finding signal, the upper board machine will send the PCB to be inserted to the left track of the machine.

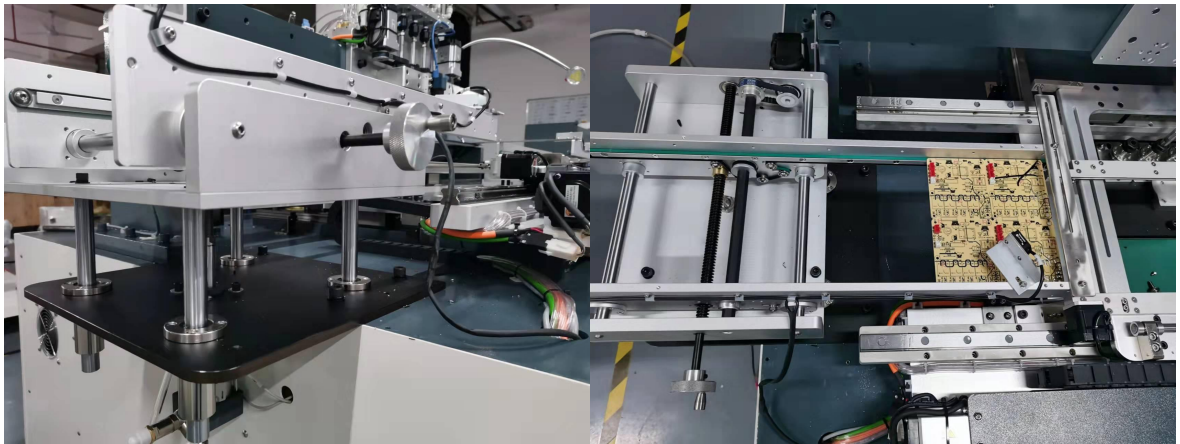

2.3.2 X-Y table

2.3.3 left track to be inserted into PCB for transportation To X-Y table. Adopt Baffle device and pressure plate cylinder setting Hold PCB

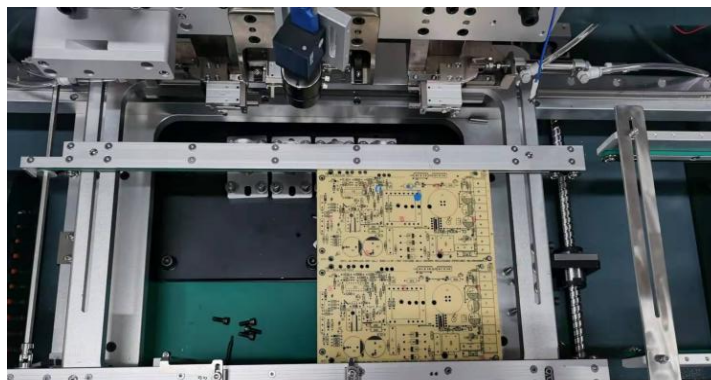

## S7020T Terminal Insertion Machine Use's Manual

## 2.3.4 Insertion head and base

(if the detection system detects that the insertion has completed successfully Go to the next step, if it is not completed, the machine will stop and report an error.) After that, the X-Y workbench will send the PCB completed by the insertion To the right track

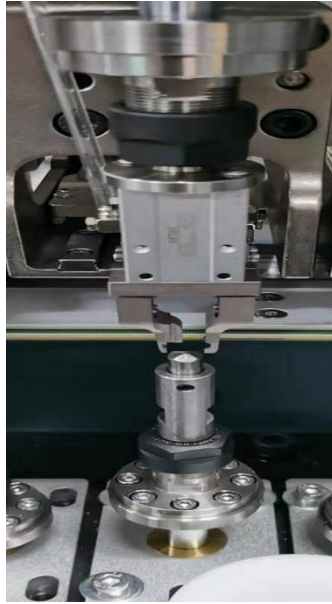

2.3.5 the left track will transport the PCB completed by the insertion to the lower board machine

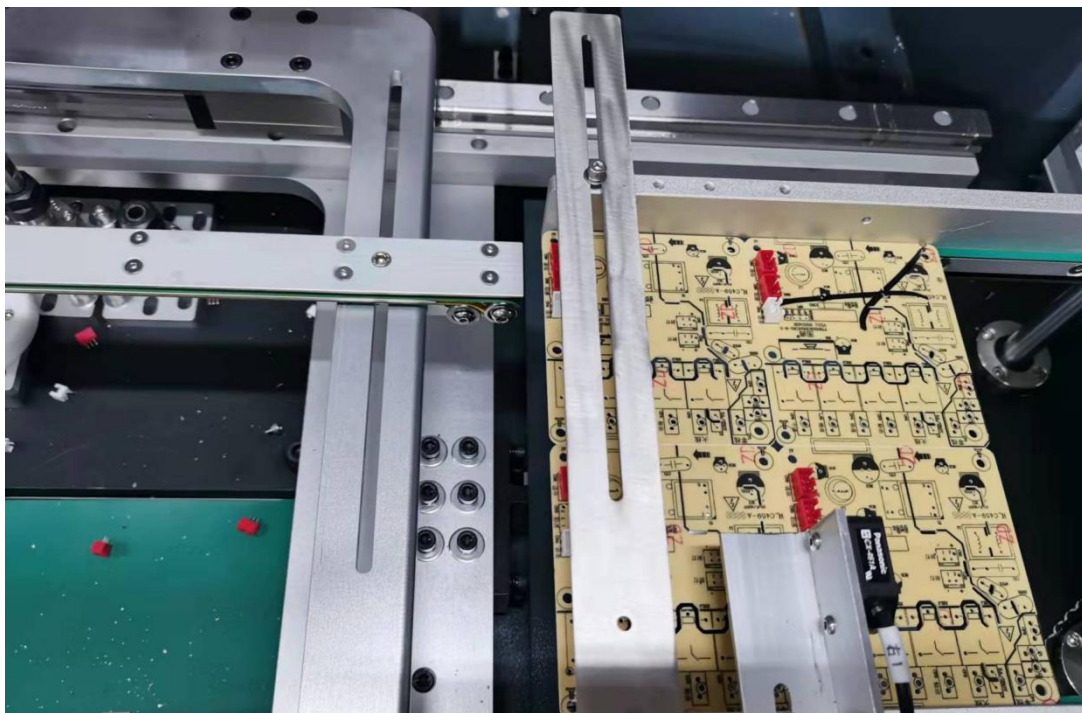

## 2.4 equipment operation steps

### Equipment operation steps (operation instructions)

#### Check the work before startup

Check the power supply.

2. Check the left air pressure gauge of the fuselage, 0.4-0.6mpa, as shown in the below image



3. Check whether there are foreign matters in the working area that may cause equipment operation failure or personal safety accident.

### Production preparation

1. Turn on the main power switch on the right side of the machine (as shown in the below image), and automatically start the industrial computer (computer).



2. After the IPC is started, open the operation software on the display desktop

3. In the upper left corner of the software interface, click "file" to open the file, and select the program in Excel format to be used.

**S7020T Terminal Insertion Machine Use's Manual**

4. Click "return to zero" on the main page to return each axis to zero once, right click "insertion" to select and set the production number, and enter the quantity to be produced.

**production**

1. Click "insertion" and input one PCB to the right side track of loader machine
2. Click "auto" and press "start" to produce.
3. Click the "single cycle / multi cycle" button to switch to single PCB production or multi PCB continuous production.
4. If the production is poorly inserted, it will stop and alarm, and there will be a pop-up window on the computer. After confirming that the part is not inserted in the current insertion hole of the PCB, press the space bar on the keyboard twice (the first press will eliminate the alarm prompt pop-up window. , the second time will continue to insert), the machine will automatically insertion the component.
5. There is a "stop" button on the computer interface and operation panel, which can stop production and press the "start" button to continue production.
6. It is strictly prohibited to extend the body into the machine during production, safety first.
7. In case of special emergency, please press "emergency stop". The machine will cut off the power and gas supply and stop working, and inform the professional technicians immediately.

**Shutdown**

1. After completing the "planned output" or the shutdown does not need to continue production, click the "zero" button to reset the X, Y worktable to the Park point, click the software interface "exit the system" and confirm, and close the software.
2. Open the "Startup" menu in the lower left corner of the Windows desktop, select "Shutdown" and confirm to turn off the industrial computer. After the industrial computer is completely shut down, turn off the main power on the right side.

### 3. Operation control procedure

#### 3.1 Introduction to operation program interface

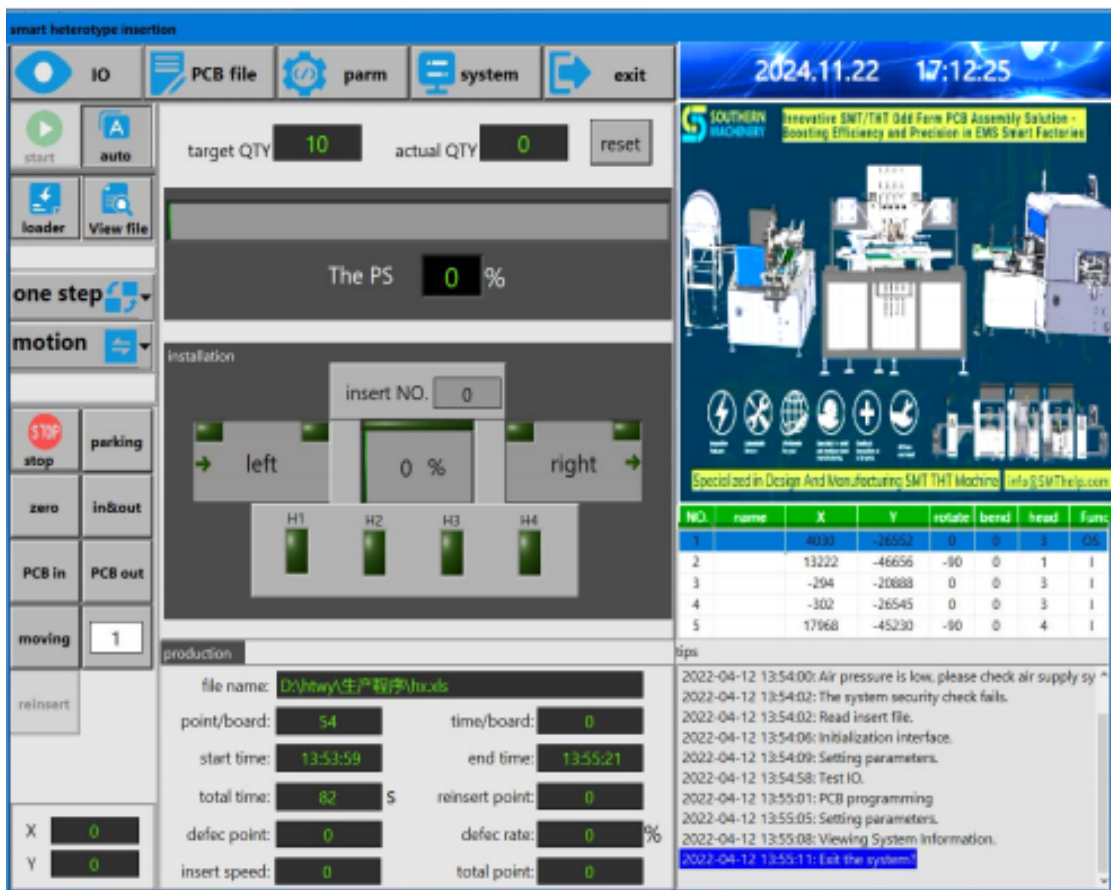

The main operation interface is divided into five areas.

1. Operation panel
2. Video and program display
3. Production data and overboard status
4. Prompt information
5. Setting function

## 3.2 Classification details of each function item

### 3.2.1 operation panel area

#### 3.2.1 Operation panel area

- Start: start work, this key is the start/stop swap bit
- Auto: After selecting Auto, production can be started. Automatic/manual swap bits. manual state Operate other functions.
- Loader: call a program that needs to be produced, and the program needs to be rewritten every time it is modified tune once.
- View File: View the content of the currently running program.
- One step: complete a certain step in the program
- One cycle: stop after one board is produced (complete one program step at a time)
- Continue: continuous production
- Step: decompose the steps of a insertion line into each small action
- Motion: move only the X and Y axes of the worktable
- Over ride: the table, head and base move, but the feeder does not move
- Insertion: In normal production state, the table, head, base, and feeder are all in action.
- Emergency stop: corresponding to the emergency stop switch on the casing
- Parking: temporarily not used
- Zero: each motor returns to the zero point from the current position (each SENSOR senses at the standard point)
- In&out: pass the PCB on the workbench to the right track and then pass the board from the left track to the workbench
- PCB In: Incoming a PCB from the left track to the workbench
- PCB out: pass the PCB on the workbench to the right track
- reinsert: perform a patch work at the current point

## 3.2.2 image and video area

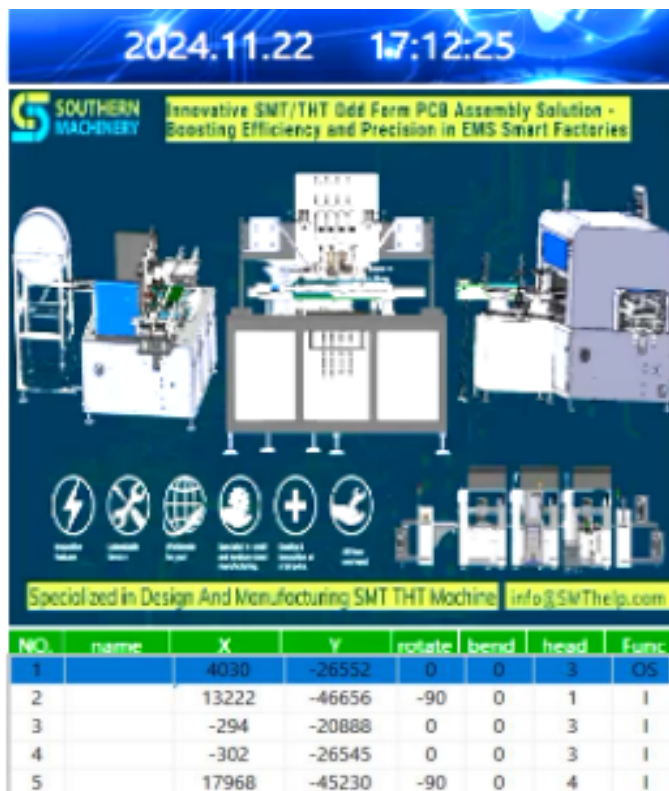

This area is the real-time PCB video area captured by the camera after the camera is turned on. Display the manufacturer's OEM information when the camera is not "on".

The lower part shows the program content, and the blue bar shows the current line

- NO: the numbers are arranged in sequence in the program
- Name: The position of the part on the PCB board is marked (silk screen name)
- X: The horizontal coordinate value of each insertion point
- Y: The vertical coordinate value of each insertion point
- Rotate: The angle that needs to be rotated when the head is plugged in, and the base also rotates
- Bend Feet: Torsion angle after the base insert is completed
- Head: the number one used by the current part

## S7020T Terminal Insertion Machine Use's Manual

- Function: All sequence lines in the program are insertion lines. and with additional functions on the plugin line.
- OS: With origin compensation function, this line can be offset, which will drive all subsequent I lines to move synchronously.
- MK: mark point, the whole board automatically offsets the reference point
- I: Basic plugin line
- S: Skip this line production
- F: End the line, manually pick and place the board in the special method of the fixture, and do not pass the board.
- E: End line, the program ends after the insertion in this line is completed, and the transfer board is performed.

### 3.2.3 Production data and overboard status

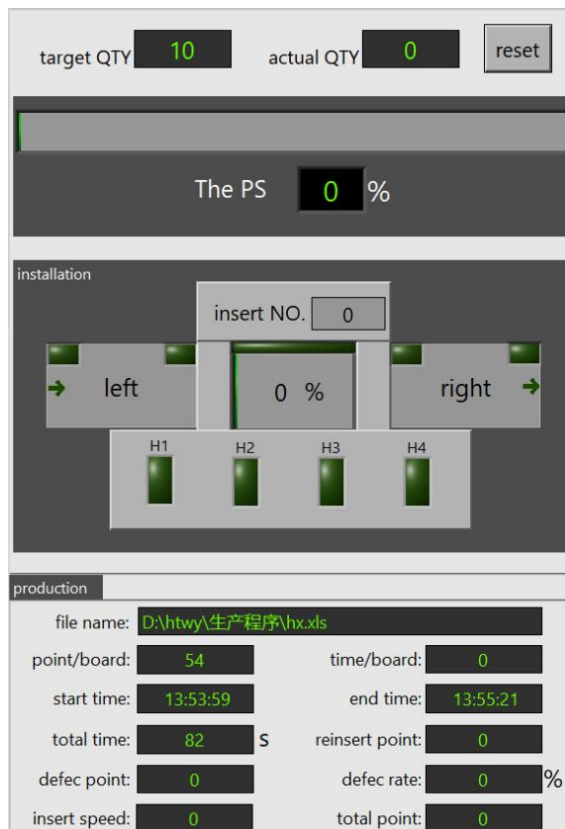

- Target QTY: the target quantity to be produced
- Actual QTY: the quantity that has been produced so far
- Production progress(The PS): the proportion of the current production quantity
- Installation: Display the production board status and which insertion head(H1-H4) is executing the insert
- Production: Displays various data of products currently produced

### 3.2.4 Prompt information

## S7020Terminal Insertion Machine Use's Manual

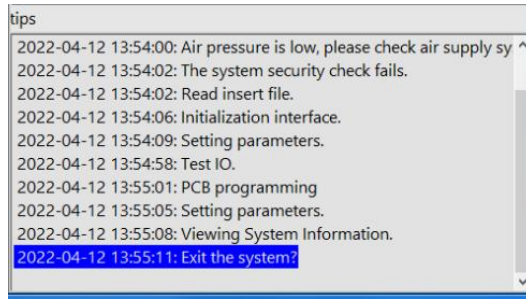

Prompt information: Display various conditions when the current device is running.  
(If there is a failure in production, see here)

### 3.2.5 Setting function(This area contains various function settings and adjustment and auxiliary information)



#### 3.2.5.1 IO

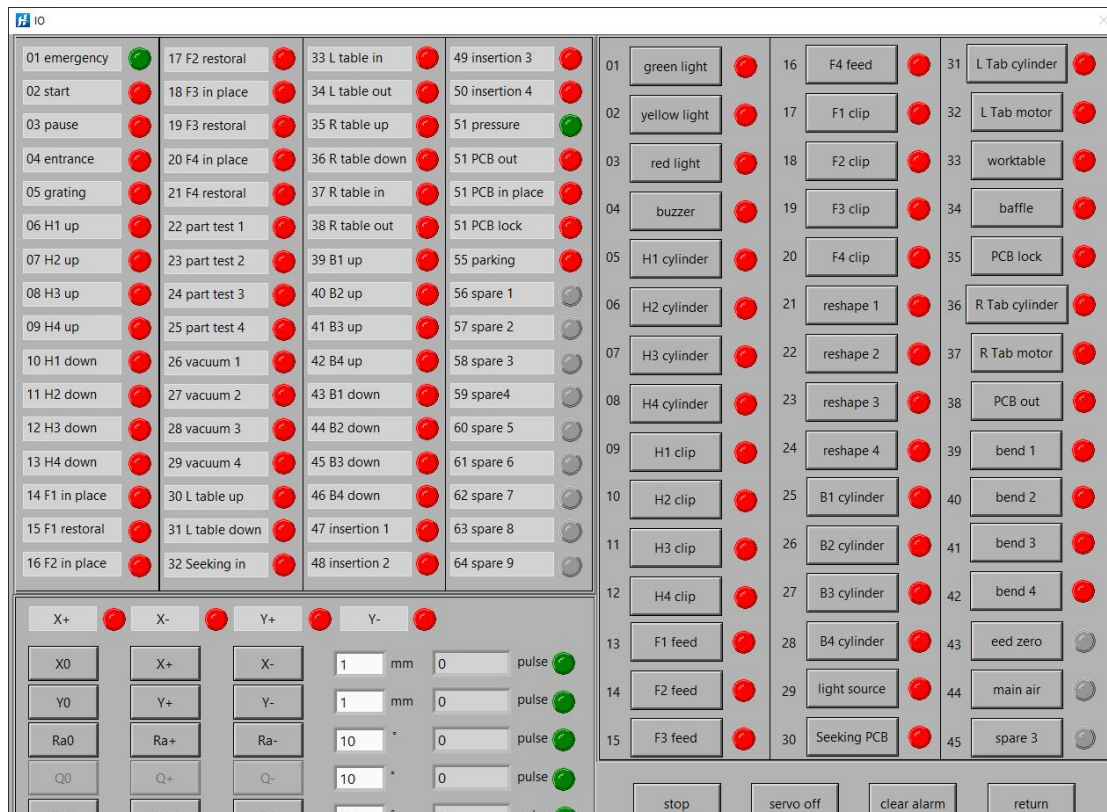

Red and green signals indicate whether it is working: the green signal is lit, indicating that it is in working state

The upper left part is the input signal (sensors, switches and other feedback signals to the computer)

1. Emergency: When the emergency stop switch on the machine casing is photographed, the state changes from "red" to "blue", the machine stops working, and the main gas source is cut off.
2. Start: corresponding to the start switch button on the machine shell
3. Pause: corresponding to the stop switch button on the machine shell
4. Entrance: when the machine safety door is opened, the state changes from "red" to "blue", and vice versa
5. Grating: red alarm, green normal
6. H1 up: the upper magnetic induction signal of the first cylinder (the cylinder corresponds to 1234 from left to right)
7. H2 up: the upper magnetic induction signal of the second cylinder
8. H3 up: magnetic induction signal of the third cylinder upper position
9. H4 up: the upper magnetic induction signal of the fourth cylinder
10. H1 down: magnetic induction signal of the first cylinder lower position
11. H2 down: magnetic induction signal at the lower position of the second cylinder
12. H3 down: magnetic induction signal of the third cylinder lower position
13. H4 down: magnetic induction signal of the fourth cylinder lower position
14. F1 in place: Magnetic induction signal before the first feeding
15. F1 restora: magnetic induction signal after the first feeding
16. F2 in place: magnetic induction signal before the second feeding
17. F2 restora: magnetic induction signal after the second feeding
18. F3 in place: magnetic induction signal before the third feeding
19. F3 restora: magnetic induction signal after the third feeding
20. F4 in place: the fourth magnetic induction signal before feeding
21. F4 restora: magnetic induction signal after the fourth feeding
22. Part test 1: The signal of the first base material detection
23. Part test 2: The signal of the second base material detection
24. Part test 3: Signal of the third base material detection
25. Part test 4: the signal of the fourth base material detection
26. Vacuum 1: The vacuum detection signal of No. 1
27. Vacuum 2: The vacuum detection signal of No. 2
28. Vacuum 3: The vacuum detection signal of No. 3
29. Vacuum 4: The vacuum detection signal of No. 4
30. L table up: Magnetic induction signal of the upper cylinder of the left connecting table
31. L table down: Magnetic induction signal of the lower position of the cylinder of the left connecting table
32. seeking in: the signal sent by the host computer to the machine
33. L table in: the signal of the sensor inside the left docking station (inside is the sensor closest to the workbench)
34. L table out: the signal from the sensor outside the left docking station
35. R table up: the upper magnetic induction signal of the cylinder of the right connecting table

**S7020T Terminal Insertion Machine Use's Manual**

- 36. R table down: Magnetic induction signal of the lower position of the cylinder of the right connecting table
- 37. R table in: the signal of the sensor inside the right docking station (inside is the sensor closest to the workbench)
- 38. R table out: the signal of the sensor outside the right docking station
- 39. B1 up: Magnetic induction signal of upper position of cylinder of base 1
- 40. B2 up: Magnetic induction signal of upper position of cylinder of base 2
- 41. B3 up: Magnetic induction signal of the upper position of the base 3 cylinder
- 42. B4 up: Magnetic induction signal of the upper position of the base 4 cylinder
- 43. B1 down: Magnetic induction signal of upper position of cylinder of base 1
- 44. B2 down: the magnetic induction signal of the upper cylinder of the base 2
- 45. B3 down: the magnetic induction signal of the upper cylinder of the base 3
- 46. B4 down: the magnetic induction signal of the upper position of the cylinder of the base 4
- 47. Insertion 1: No. 1 header insertion detection signal
- 48. Insertion 2: No. 2 header insertion detection signal
- 49. Insertion 3: No. 3 header insertion detection signal
- 50. Insertion 4: No. 4 header insertion detection signal
- 51. Pressure: detection signal of electronic barometer alarm
- 52. PCB out: the signal sent by the lower machine to the machine
- 53. PCB in place: signal for PCB in place
- 54. PCB lock: PCB locking signal
- 55. Parking: Induction to detect whether the workbench is parked in the X-direction parking position.
- 56-64: This machine does not need to be used

The right side is the general output, the interface that can be operated. After the mouse clicks on the middle grid, the red and green colors on the right side will switch. Green means in working state.

## S7020T Terminal Insertion Machine Use's Manual

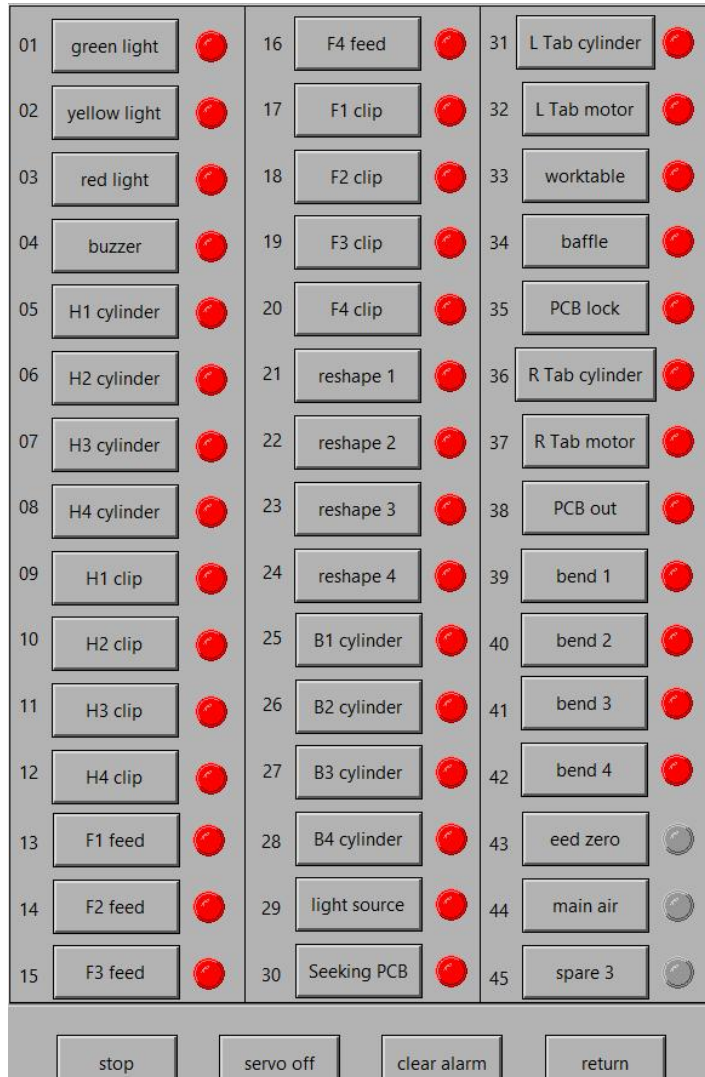

- 01: Green light control of indicator light,  
 02: Yellow light control of indicator light  
 03: Red light control of indicator lights  
 04: Buzzer control of indicator lights  
 05: H1 cylinder drives down.  
 06: H2 cylinder drives down.  
 07: H3 cylinder drives down.  
 08: H4 cylinder drives down.  
 09: The No. 1 insertion head is clamped.  
 10: The No. 2 insertion head is clamped.  
 11: The No. 3 insertion head is clamped.  
 12: The No. 4 insertion head is clamped.  
 13: The feeding cylinder of No. 1 drives forward.  
 14: The feeding cylinder of No. 2 drives forward.  
 15: The feeding cylinder of No. 3 drives forward.  
 16: The feeding cylinder of No. 4 drives forward.  
 17: The clamping cylinder on the No. 1 feeding component is driven to clamp the first material on the track.

**S7020T Terminal Insertion Machine Use's Manual**

- 18: The clamping cylinder on the No. 2 feeding component is driven to clamp the first material on the track
- 19: Driven by the clamping cylinder on the No. 3 feeding component to clamp the first material on the track
- 20: Driven by the clamping cylinder on the No. 4 feeding component to clamp the first material on the track
- 21: The component of No. 1 head is cut into shape. Add a micro-shaping function for bad materials at the entrance of the track. (for special materials)
- 22: The component of No. 2 head is cut into shape.
- 23: The component of No. 3 head is cut into shape.
- 24: The component of No. 4 head is cut into shape.
- No. 1 Base cylinder drives up.
- 26: No. 2 Base cylinder drives up.
- 27: No. 3 Base cylinder drives up.
- 28: No. 4 base cylinder drives up.
- 29: A backlight source under the camera (above the base).
- 30: The machine sends a signal to the upper computer to request to enter the board
- 31: The left connecting cylinder controls the lifting and lowering of the left connecting table cylinder
- 32: The motor of the left connecting table controls the rotation of the motor of the left connecting table, so that the left connecting table can enter the worktable.
- 33: Workbench motor, control the rotation of the workbench motor
- 34: Baffle, drive the baffle cylinder to control the position where the PCB board stops
- 35: PCB locking, controlling positioning parts and positioning horses, so as to realize the fixing of PCB board
- 36: The cylinder of the right connecting table controls the lifting and lowering of the cylinder of the right connecting table
- 37: The motor of the right connecting table controls the rotation of the motor of the right connecting table, so as to realize the downward triggering of the right connecting table.
- 38: Request to output the board, send a board output signal to the lower computer to realize the board output
- 39: The bent foot cylinder of the No. 1 base realizes the alternative bending foot of the material (the bending foot treatment of the special material)
- 40: The bent foot cylinder of the No. 2 base realizes the alternative bent foot of the material (the bent foot of the special material)
- 41: The bent foot cylinder of the No. 3 base realizes the alternative bent foot of the material (the bent foot of the special material)
- 42: The bent foot cylinder of the No. 4 base realizes the alternative bending foot of the material (the bending foot treatment of the special material)
- 43: Feeding back to zero: the control of returning to the origin with the material output
- 44: Not enabled
- 45: Not enabled

Dedicated output:

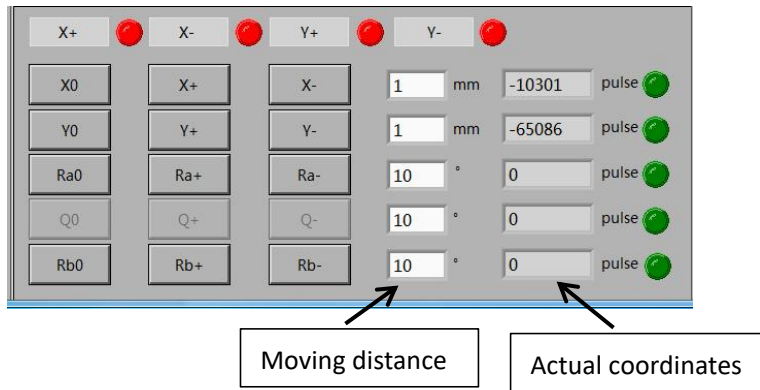

The first line: XY axis limit sensing, red is normal.

XO, YO, RaO, QO, RbO: each axis returns to the origin.

+: The motors of each axis move in the positive direction.

-: The motors of each axis move in the negative direction.

### 3.2.5.2 PCB Programming

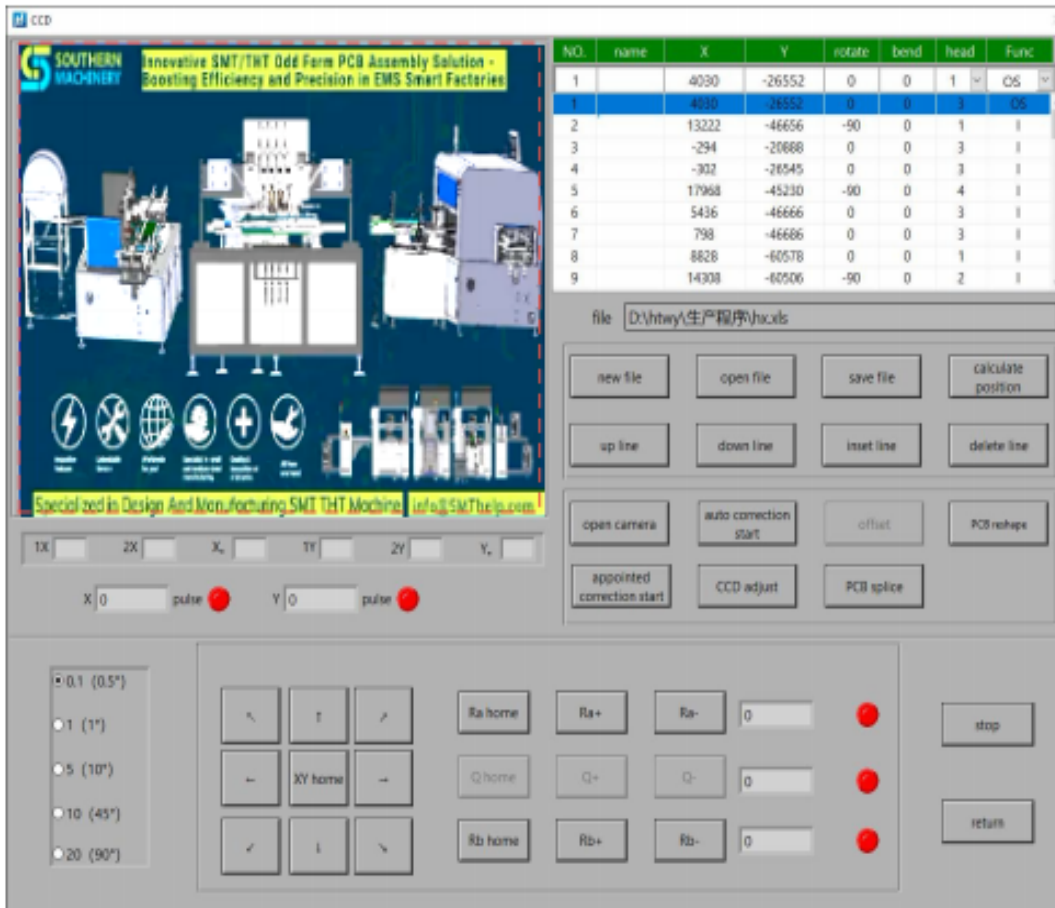

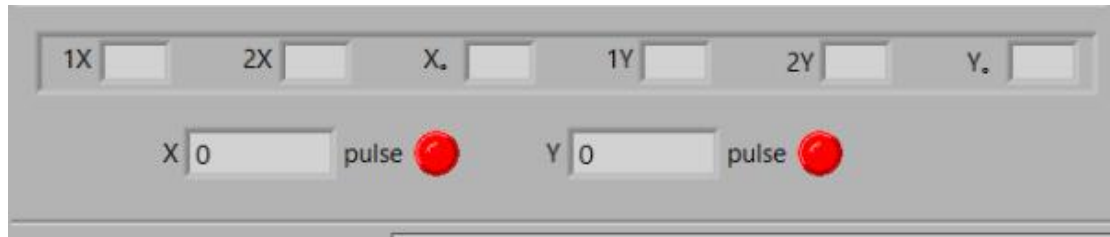

The upper left corner is the PCB image display area, and below it are the 2 selected holes and the current coordinate values;

The upper right corner is the program display, the top row is the modification row, and the current cursor row can be modified, and the following is the program step.

Operation part:

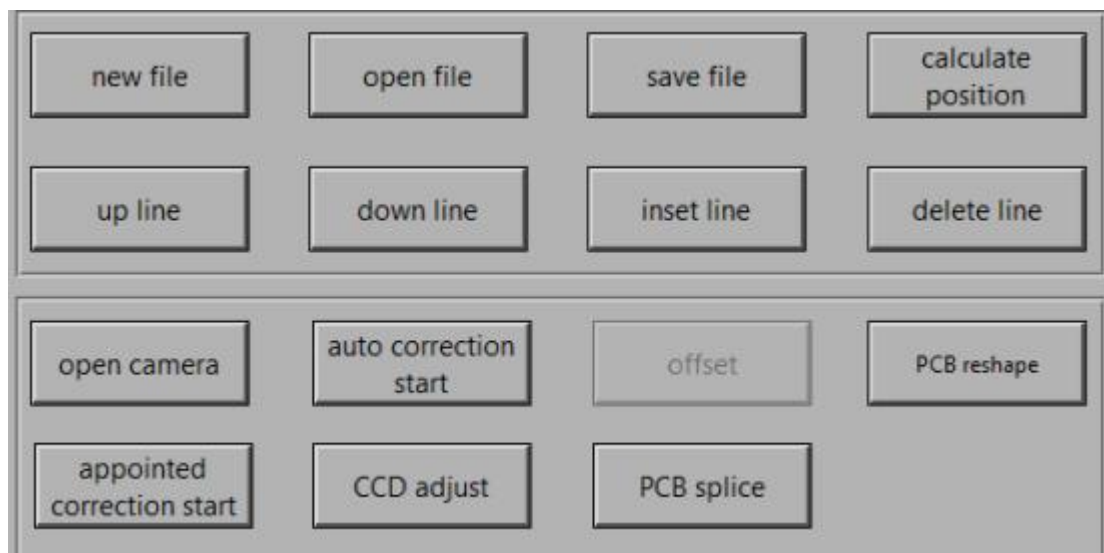

- New file: Create a blank new program (required for program)
- Open file: Open a previously edited program
- Save file: save the edited program to the computer
- Calculate position: Input the modified content of the modification line into the program line
- Up line: in the sequence of program steps, take one step from the cursor line
- Down line: in the sequence of program steps, take one step from the cursor line
- Insert line before: inserts a point from the front of the cursor line
- Delete line: delete the current line of the cursor line
- Open camera: open the camera used for head photo school
- Auto correction start: all automatic calibrations are performed according to the program step by step
- Offset: It can only be used in the OS line, and it will move the OS and the I line behind it as a whole

## S7020T Terminal Insertion Machine Use's Manual

- PCB reshape: Convert a program with multiple OS into a program with only one OS
- Appointed correction start: calibrate the current cursor line
- CCD adjust: Adjust the relative position of the head and the camera
- PCB splice: When the program has only one OS, the cursor line must be in the first OS line to select the panel. Enter as many values as there are small panels on a large piece.



### Bottom part:

Left: a ratio or size by which the coordinates (angles) move

Arrow area: X, Y coordinates can be moved in eight directions

RA (Q, RB) return to zero: click the angle between the head and the base to return to the zero position

RA+ (Q+, RB+): Click each axis to rotate clockwise once

RA-(Q-, RB-): After clicking, each axis rotates counterclockwise once

White grid area: Displays the current angle value of each axis

Motion stop: optional function, not required.

### 3.3 Camera Adjustments:

CCD

**Head offset**

Head offset	H1	H2	H3	H4
X:	45727	15719	-2349	-44232
Y:	-29232	-28867	20246	-28603

H1  
 H2  
 H3  
 H4

0.01 (0.5°)  
 0.1 (1°)  
 1 (10°)  
 5 (45°)  
 10 (90°)

When the coordinates are corrected, we will enter the camera adjustment to correct the insertion position of the head, and the value moved by the lower moving area will be reflected in the upper head offset parameter in real time.

This offset is the same as the offset in the normal parameters in the device parameters.

Which header is used by the current line of the program, which is the default header here, and there is no need to select or select it.

The middle part of the function driver is set up to cooperate with the modification of the head offset parameter. After executing the reclaiming and placing the head, the same point corresponding to 180 degrees can be inspected.

### 3.4 Production Programming

Open the PCB programming of the main interface, and make a new program step:

1. Click "New Program" to create a blank program

As shown in the below picture

After confirming the size of the PCB board, the track will automatically adjust its width

Click Next, scan the material model, click H2 for F2 material, and then scan the barcode or QR code on the material. Similarly, click H3 for F3 material.

If you do not need to scan the material QR code, skip it directly.

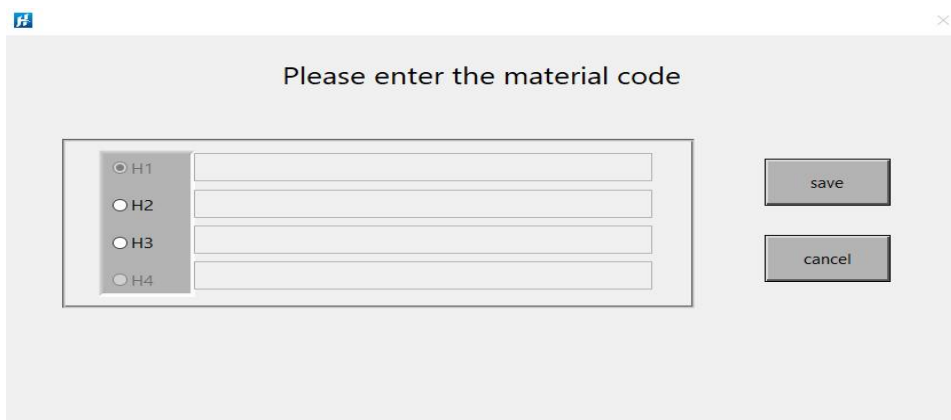
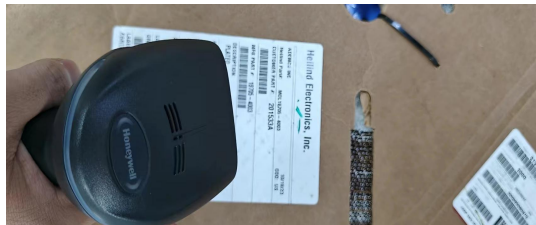
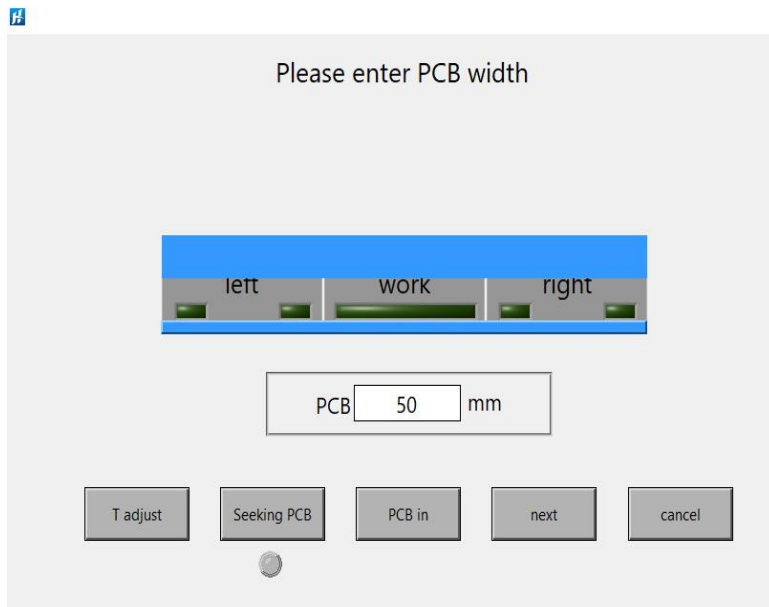

## S7020T Terminal Insertion Machine Use's Manual

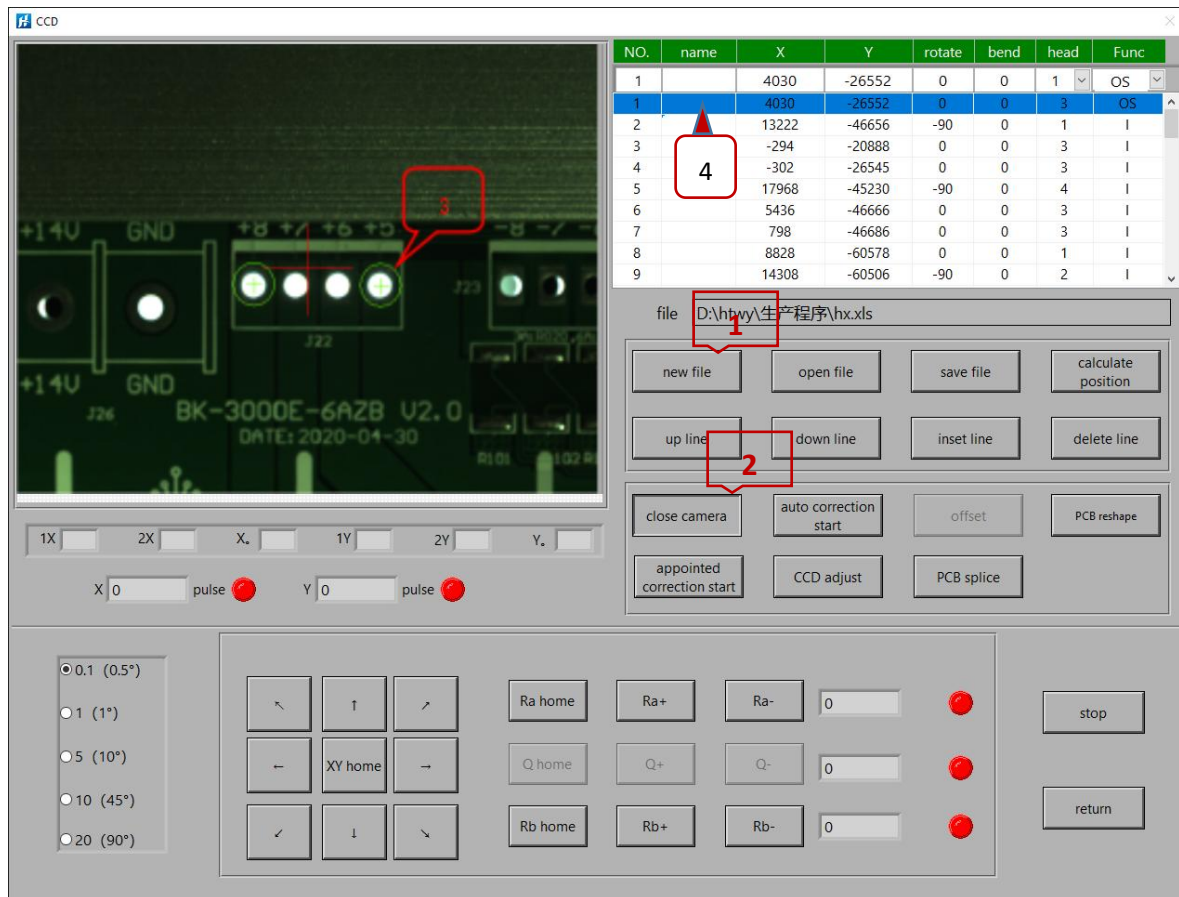

2. Click "Open Camera", move the X and Y coordinates so that the point that needs the insertion enters the image area
3. Click the corresponding hole position (two points to be symmetrical) with the mouse, and the coordinates will automatically appear in the modification line on the right
4. Modify part name, rotation (angle), insertion head, function, etc.
5. Click "calculate position", the system will include the content of the modified line into the program line to form the first line, and the cursor will move to the second line at the same time

序号	零件名	X	Y	旋转	弯角	插件头	功能
2	J22	463	-55751	0	0	1	I
1	J22	463	-55751	0	0	1	OS

6. Continue to move the coordinates to the second point, select the image point, modify its content, and then enter



7. Parts of different shapes are selected symmetrically on the image selection point  
The system will calculate its center point to give a standard coordinate.

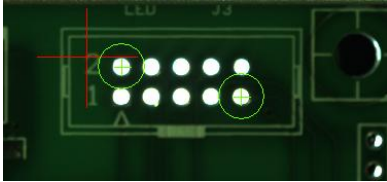

8. After editing and inputting all the points, click to save the program, and at "File name (N):", give the name of the program you want to use. Press OK to finish

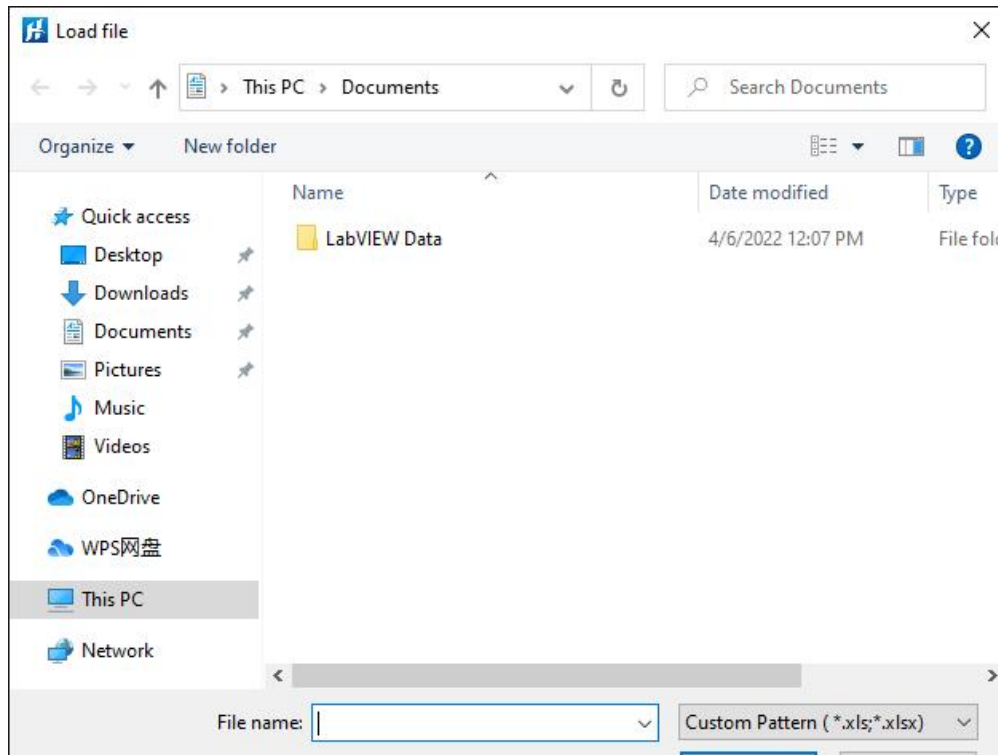

Note: After completing the program or modifying the program, you need to reopen the program on the operation interface.

3.4 Parameter setting: common parameters(The current parameters must be backed up before modification)

## S7020T Terminal Insertion Machine Use's Manual

Common parameters
✕

head offset		H1	H2	H3	H4
X:		45727	15719	-14167	-44232
Y:		-29232	-28867	-28829	-28603

servo		n speed	target speed	zero speed	ACC time	equivalent	max speed
X		1000	200000	1000	30	500	200000
Y		1000	200000	1000	40	500	200000
Ra		1000	10000	1000	10	3	200000
Rb		1000	10000	1000	10	3	200000
Q		1000	10000	1000	10	3	200000

delay (ms)		F1 feed		F2 feed		F3 feed		F4 feed		PCB in	
F1 clip	20	F2 clip	10	F3 clip	10	F4 clip	20	PCB out	0		
H1 clip	20	H2 clip	10	H3 clip	20	H4 clip	20	suction	0		
H1 restoral	30	H2 restoral	30	H3 restoral	30	H4 restoral	30	Z clip	0		
insertion1	10	insertion2	10	insertion3	10	insertion4	10	PCB lock	0		
B1 up	10	B2 up	10	B3 up	10	B4 up	10	component	0		

neout (ms)		R move		Q move		XY move		worktable in		H cylinder	
R zero	3000	Q zero	3000	XY zero	3000	worktable out	3000	table cylinder	3000		
insertion	100	seeking PCB	3000	table in	3000	table out	3000	PCB lock	1000		

CCD		CCD ratio X		CCD ratio Y	
correcting delay	500	RO	70		

other		H1 H2 H3 H4			
H enable	<input checked="" type="radio"/>	<input checked="" type="radio"/>	<input checked="" type="radio"/>	<input checked="" type="radio"/>	
reshape enable	<input type="radio"/>	<input type="radio"/>	<input type="radio"/>	<input type="radio"/>	
reshape T1	1000	reshape T2	1000		
reshape T3	1000	reshape T4	1000		
log days	30	log time	1	h	
reinsert NO.	0	reshape wait	1	S	
part test time	1	S			
over board not insert	<input type="radio"/>				

Apply&save
engineer parm
backup parm
card reset
reset parm
return

- Head offset X (H1-4): the center of the camera is zero, the relative coordinate value of the axis of each insertion head on the X axis
- Head offset Y (H1-4): the center of the camera is zero, the relative coordinate value of the axis of each insertion head on the Y-axis

Servo parameters: the speed of the drive to control the motor, such as initial speed, target speed (normally modifiable speed), zero return speed, and maximum speed. Generally, the default factory settings are sufficient.

#### Delay (ms):

- Feeding delay (F1-F4): The delay after the feeding action of the feeder (when the feeding is in place, extend this time and then start the next action, the following delays have the same meaning)
- F clip delay (F1-F4): delay after the clip of the feeder is clamped
- H clip delay (H1-H4): the delay after the insertion head clip is clamped
- H reset delay (H1-H4): When the head cylinder is reset, the head angle reset can be performed only after this delay is executed when it is separated from the lower sensor.
- insertion detection (1-4): When the insertion head is in the lower position and the base is in the upper position, a material detection will be performed. This item increases the detection time.

**S7020T Terminal Insertion Machine Use's Manual**

- B rising delay: a delay before the base rises, (that is, the base can be made a beat slower than the head)
- PCB in: There is a gap between the PCB induction and the baffle, extending the board in-position time to control the platen.
- PCB out: Control the time of out-of-board.
- Suction delay: not used yet
- Z clip delay: not used yet
- PCB lock: not used yet

**Timeout (ms):**

- R, Q, XY motion: each axis alarms when it is running, and it will alarm if it fails to complete within the set time.
- Worktable in: When the left connection board is connected to the workbench, it will give an alarm over time.
- H cylinder: The head cylinder fails to sense the sensor when driving and overtime alarms.
- R, Q, XY zero: each axis time-out alarm during zero return process.
- Worktable out: When the worktable ejects the board to the right connecting table, it will give an alarm over time.
- Table cylinder: Time-out alarm when the left and right connection tables are driven up and down.
- insertion detection: When the insertion fails to be detected within this time, it will alarm.
- Seeking PCB: The machine has not entered the board time-out alarm while requesting the board from the upper computer.
- Table in: When the transfer board from the host computer enters the left connection, the timeout is not in place, and the alarm is given.
- Table out: when the right connection table is out of the board to the lower computer, there is an abnormal alarm.
- PCB lock: After the PCB is in place, the locking cylinder fails to sense the pressure and will cause a timeout alarm.

**CCD:**

- CCD ratio X:Defaults
- CCD ratio Y:Defaults
- Correction Delay (ms):Defaults
- ROI:Defaults

## S7020T Terminal Insertion Machine Use's Manual

Common parameters
✕

head offset		H1	H2	H3	H4
X:		45727	15719	-14167	-44232
Y:		-29232	-28867	-28829	-28603

servo		n speed	target speed	zero speed	ACC time	equivalent	max speed
X		1000	200000	1000	30	500	200000
Y		1000	200000	1000	40	500	200000
Ra		1000	10000	1000	10	3	200000
Rb		1000	10000	1000	10	3	200000
Q		1000	10000	1000	10	3	200000

delay (ms)		F1 feed		F2 feed		F3 feed		F4 feed		PCB in	
F1 clip	20	F2 clip	10	F3 clip	10	F4 clip	20	PCB out	0		
H1 clip	20	H2 clip	10	H3 clip	20	H4 clip	20	suction	0		
H1 restoral	30	H2 restoral	30	H3 restoral	30	H4 restoral	30	Z clip	0		
insertion1	10	insertion2	10	insertion3	10	insertion4	10	PCB lock	0		
B1 up	10	B2 up	10	B3 up	10	B4 up	10	component	0		

neout (ms)		R move		Q move		XY move		worktable in		H cylinder	
R zero	3000	Q zero	3000	XY zero	3000	worktable out	3000	table cylinder	3000		
insertion	100	seeking PCB	3000	table in	3000	table out	3000	PCB lock	1000		

CCD		CCD ratio		correcting delay		ROI	
CCD ratio X	47.2	CCD ratio Y	47.2	correcting delay	500	ROI	70

**other**

H1 H2 H3 H4  
H enable

reshape enable

reshape T1 1000 reshape T2 1000  
reshape T3 1000 reshape T4 1000

log days 30 log time 1 h

reinsert NO. 0 reshape wait 1 S

part test time 1 S

over board not insert

Apply&save
engineer parm
backup parm
card reset
reset parm
return

**Other parameters:**

- H Enable: After selecting it, the corresponding header can be enabled. If there are only two headers, 2/3 headers can be enabled.
- Reshape enabled: Corresponding to 21-24 in IO output, which header is used and which one is selected. Production starts as soon as it starts.
- Reshape(T1-T4): Integer cylinder action frequency.
- Log days: the number of days that the log in the working state is stored in the computer, and it is automatically deleted when it exceeds.
- Log time: not enabled yet
- reshape wait Time: The length of time an Integer will continue to work after a shutdown.
- Part test time: the detection time of materials in the track.
- Automatic overboard without inserting: only overboard, not inserting. Use this unit as a bridge.

### 3.5 Engineer parameters(Defaults)

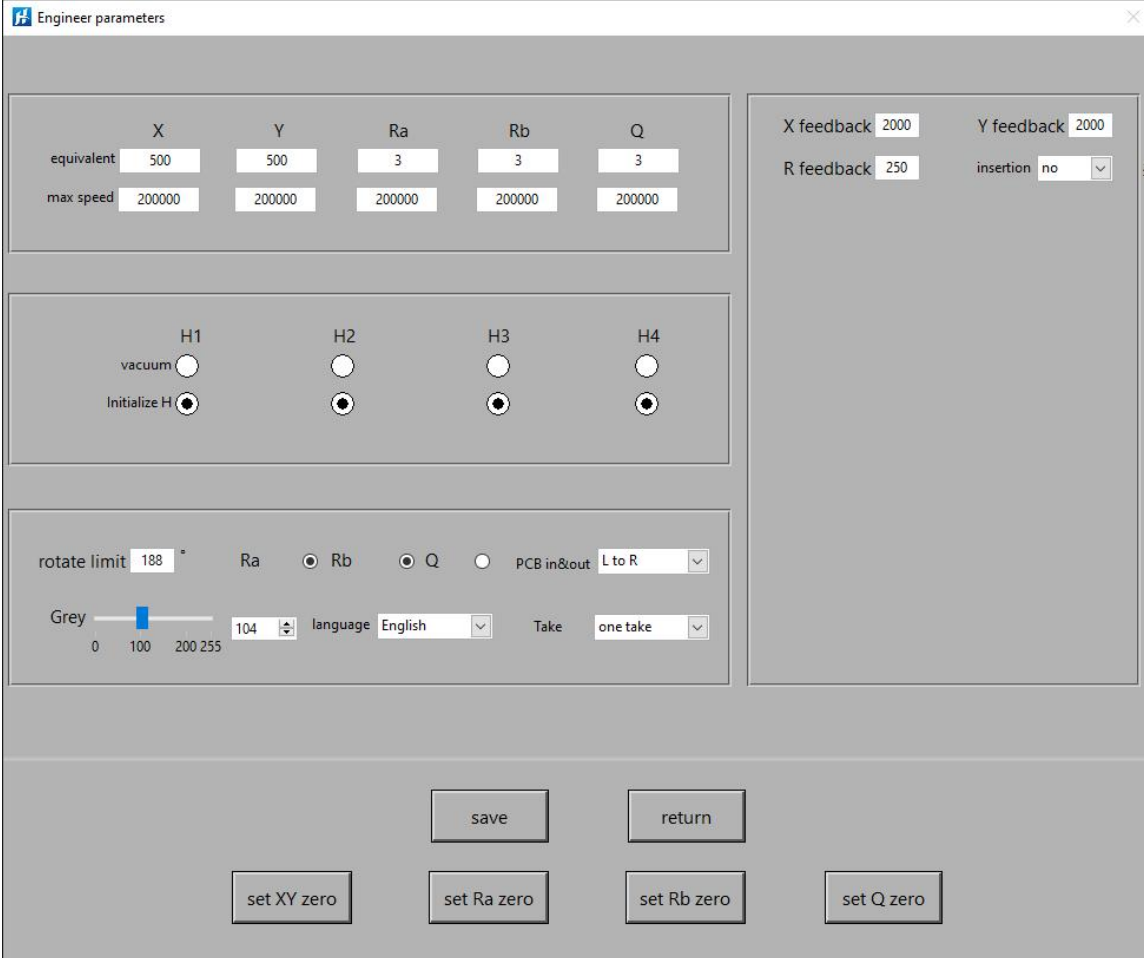

Pulse equivalent:

Maximum speed: limit the maximum number of settings for each axis.

Whether it is vacuum:

Initialize the header:

Rotate limit: If the set angle is exceeded, it will alarm.

Ra enable: click on the software to use the Ra motor

Rb enable: the software uses the Rb motor after clicking

Q Enable: After clicking, the software uses the Q motor

Loading and unloading plate direction: the direction of conveying.

Language: can switch between Chinese and English

Reclaiming method: step-by-step reclaiming (complete one-point reclaiming and inserting separately) and synchronous reclaiming (one head can be inserted, and the other head can be reclaimed)

X feedback limit:

Y feedback limit:

Rotational feedback limit:

Plugin detection:

Set the origin:

#### 3.2.5.4 System Information

Click here to see the company name of this product

#### 3.2.5.5 Exit the system

Click to jump out of the Yes or No option window

Choose Yes or else to exit the system.

## 5. Panasonic Servo Introduction

### 4.1 Drive USB debugging

1. Plug the USB cable into the drive (the outgoing cable is outside the slot)



2. Double-click to open the desktop PANATERM software

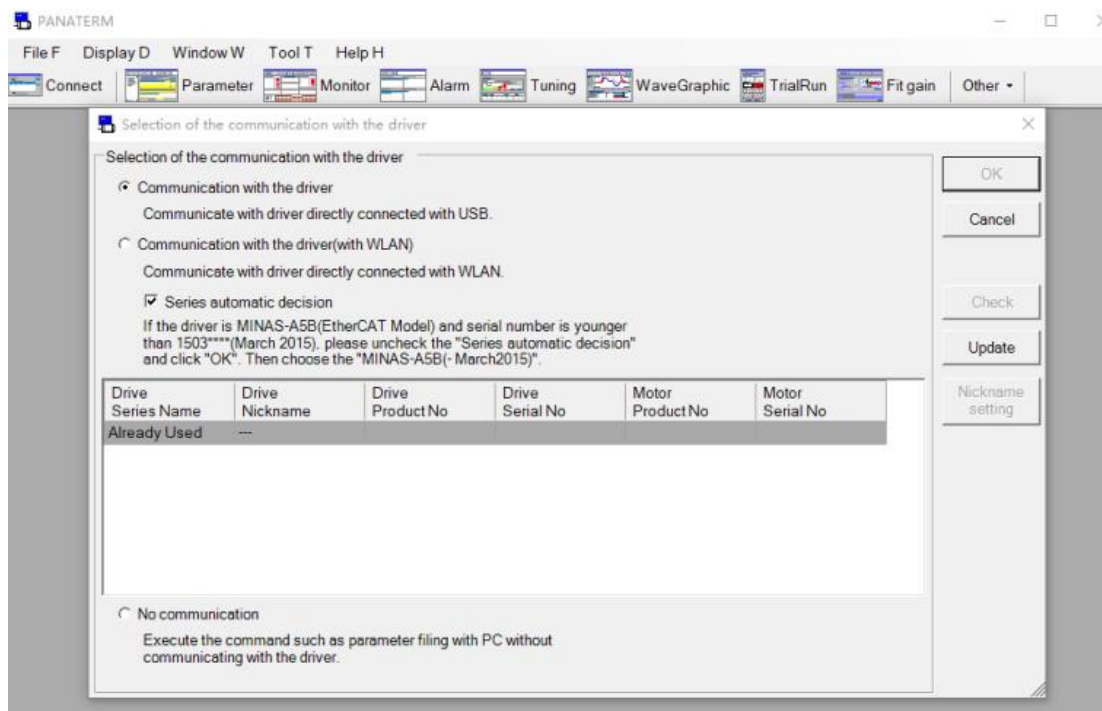
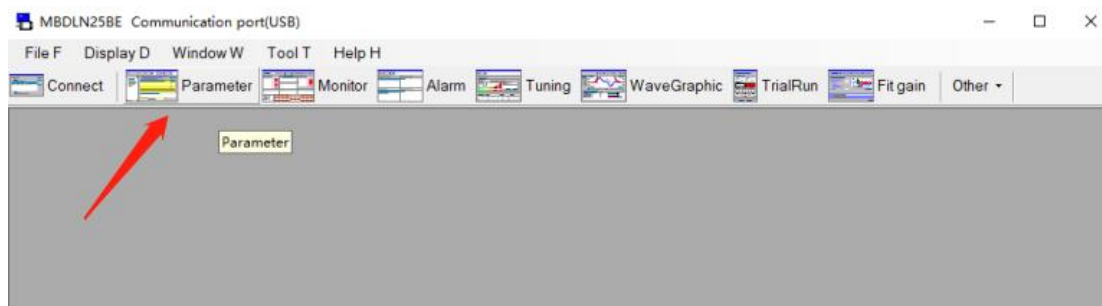
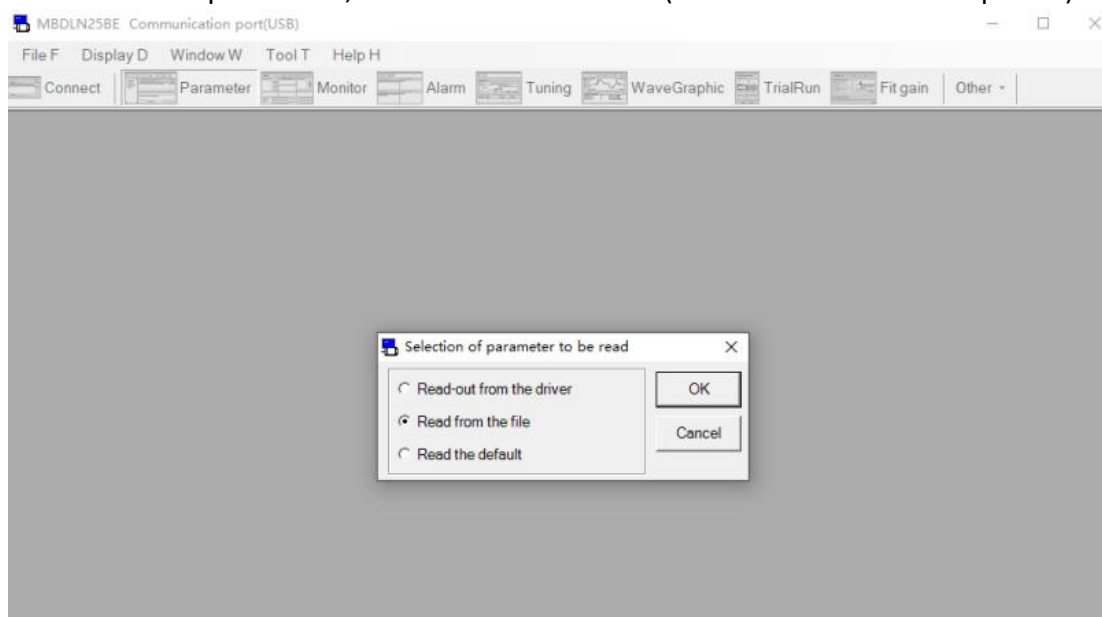

3. Choose to communicate with the drive via USB cable

**S7020T Terminal Insertion Machine Use's Manual**

**4. Parameter selection**

**5. Click on the parameter, then read from the file (the file will be backed up here)**

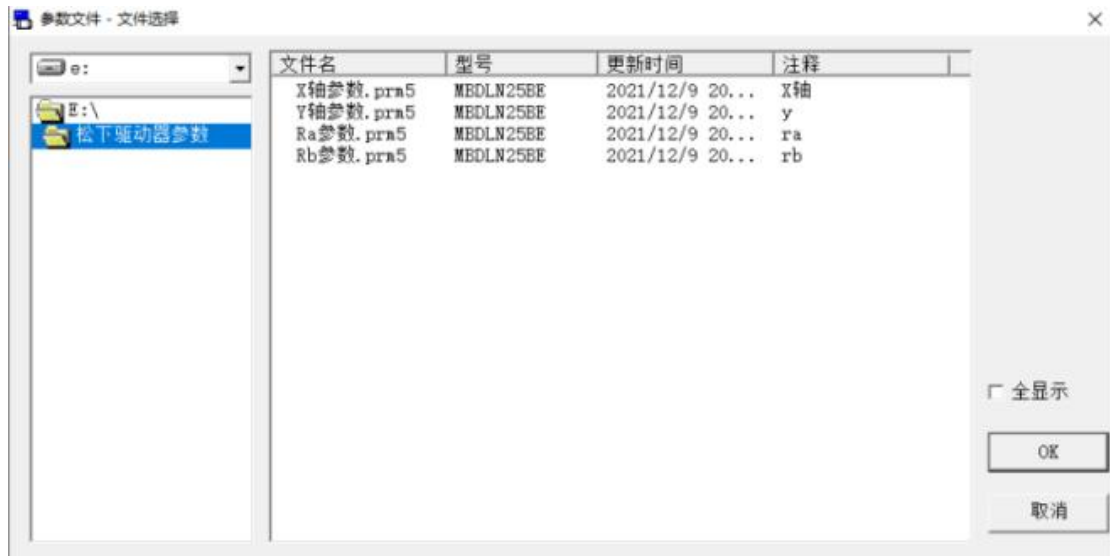
## S7020T Terminal Insertion Machine Use's Manual

6. Select the axis to be commissioned

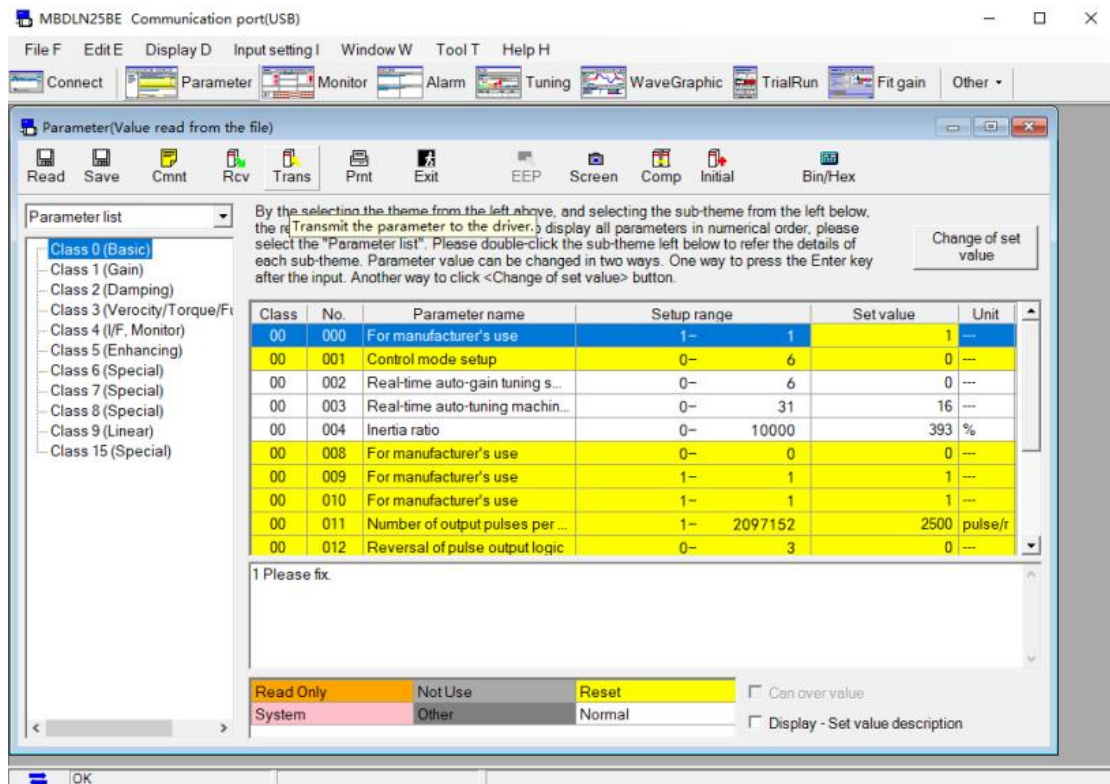

7. The demonstration here selects the X axis, and then transfers the parameters to the driver



**S7020T Terminal Insertion Machine Use's Manual**

8. After the transmission is completed, select EEP to write, and the parameters that will be modified will pop out after writing.



9. This is the parameter that needs to be modified for the X-axis drive. A series of parameters can be modified in one step with file extraction and writing.

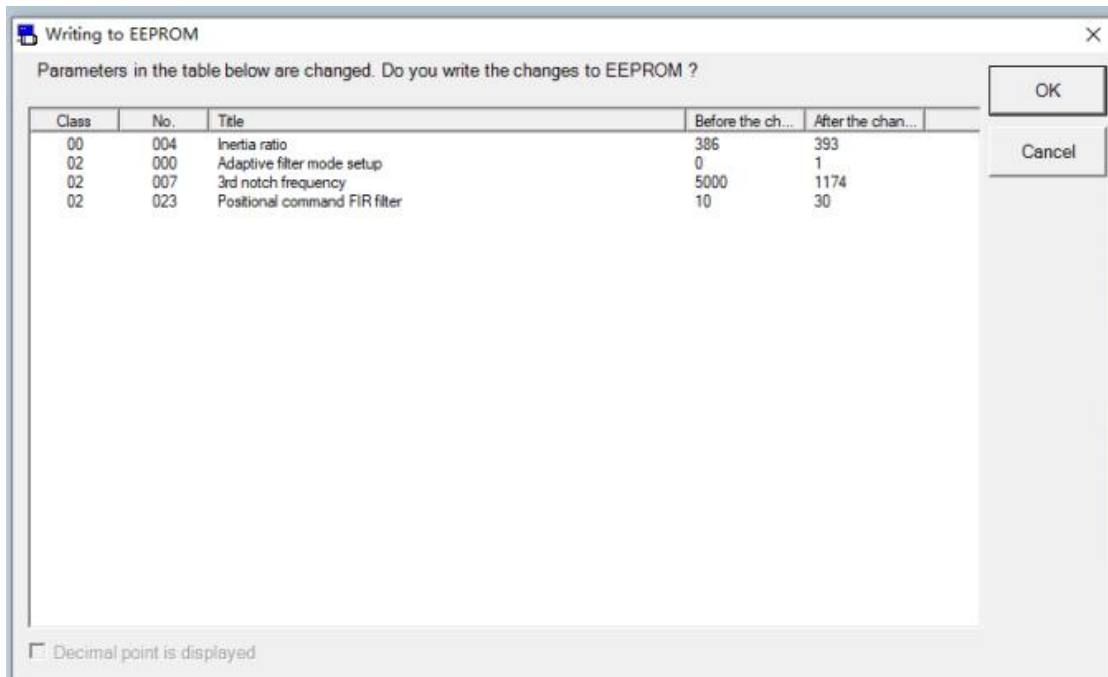

10. Object Editor

11. Select Object Editor in Other

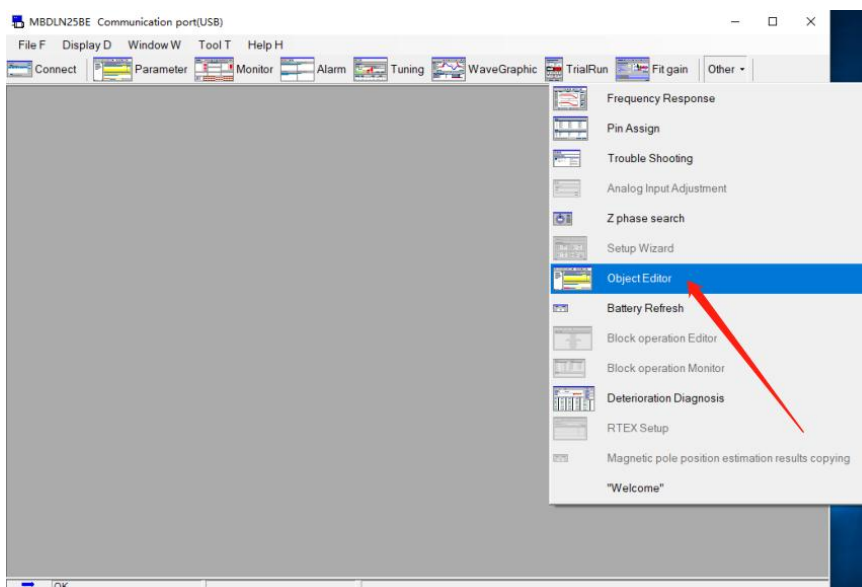

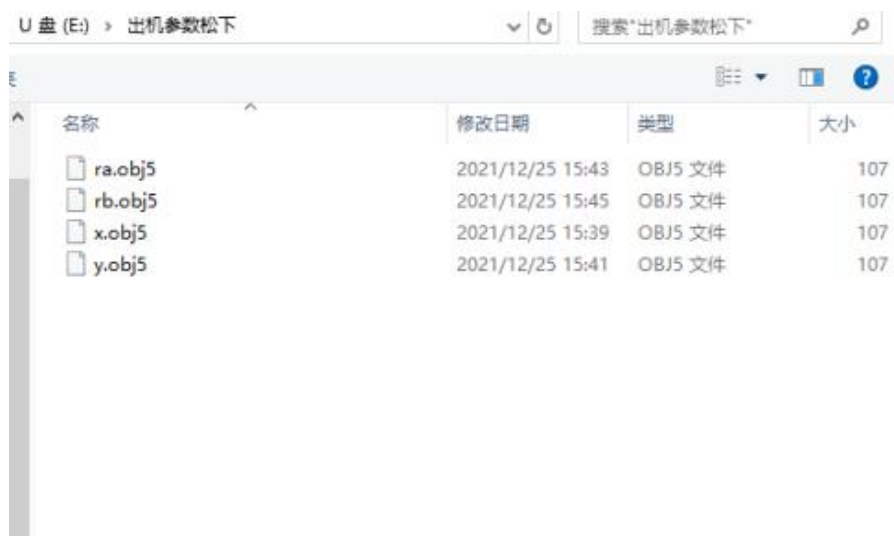
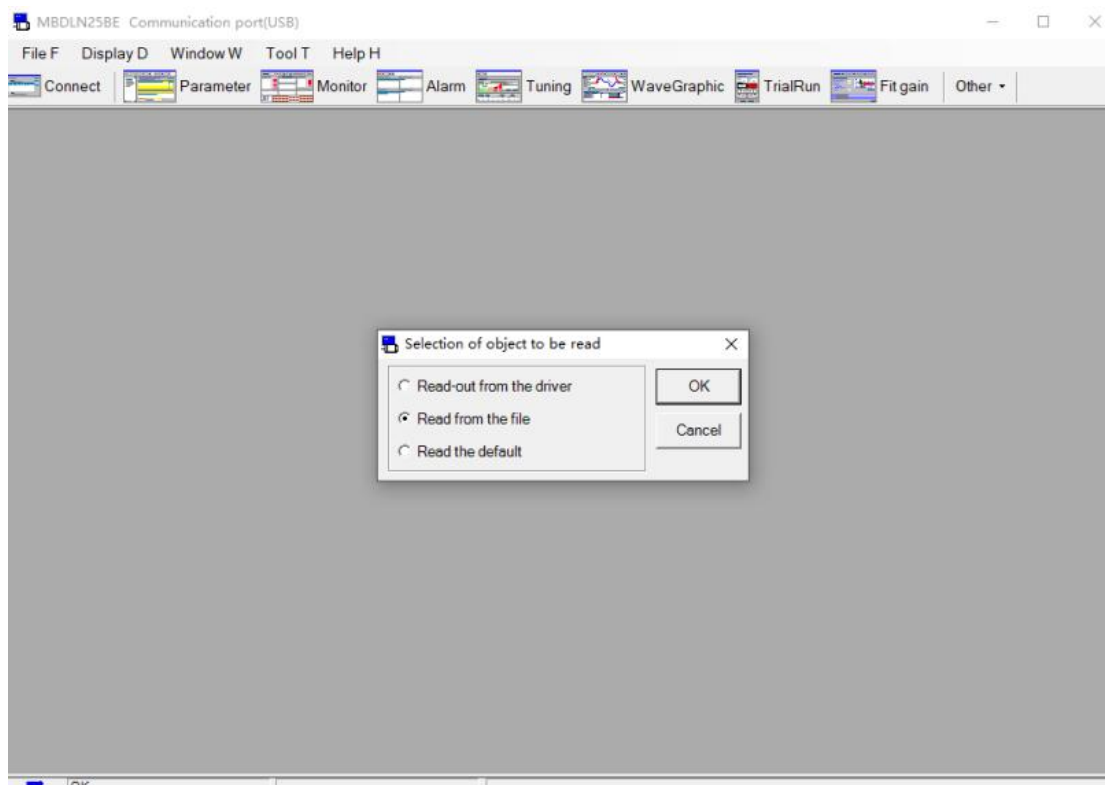
**S7020T Terminal Insertion Machine Use's Manual**
**12. Jump out of the selection box, read the file from the file to find the X-axis**

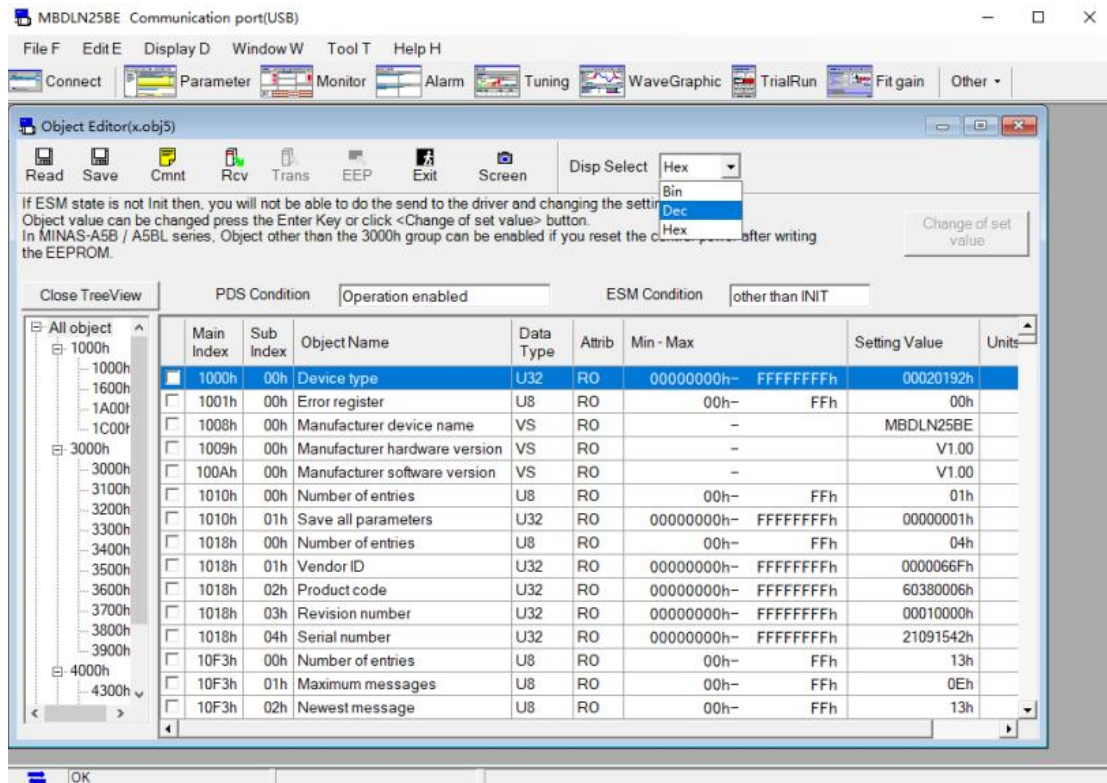
**13. Modify the displayed value to decimal and change Hex to Dec in Disp Select**

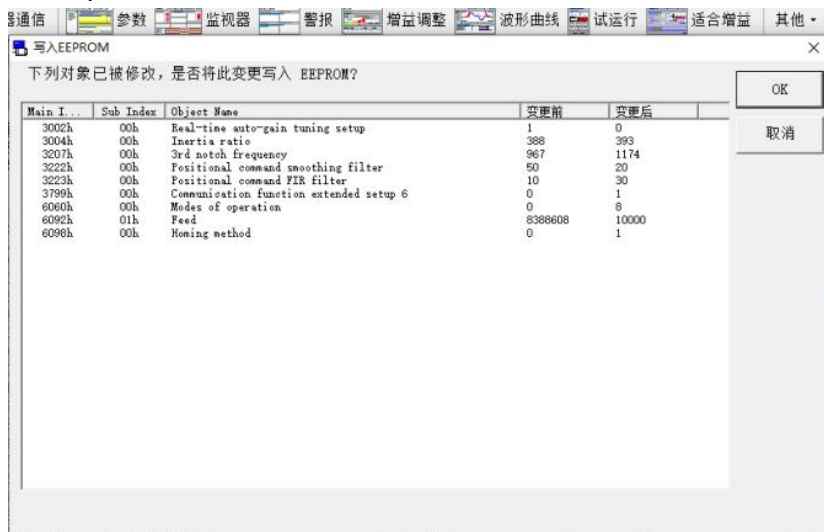
**S7020T Terminal Insertion Machine Use's Manual**

**14. transfer data to the drive**

**15. EEP writing will jump out of the data that needs to be modified. Click OK to modify the data.**

## S7020T Terminal Insertion Machine Use's Manual

## 16. Monitor

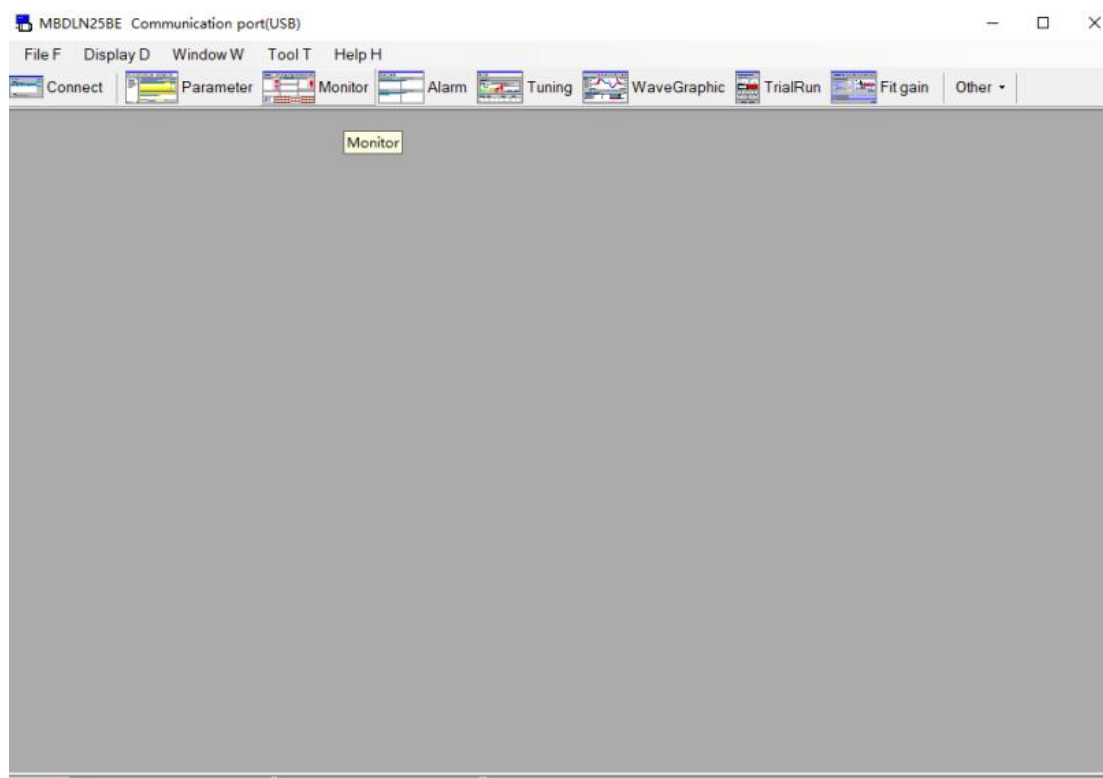
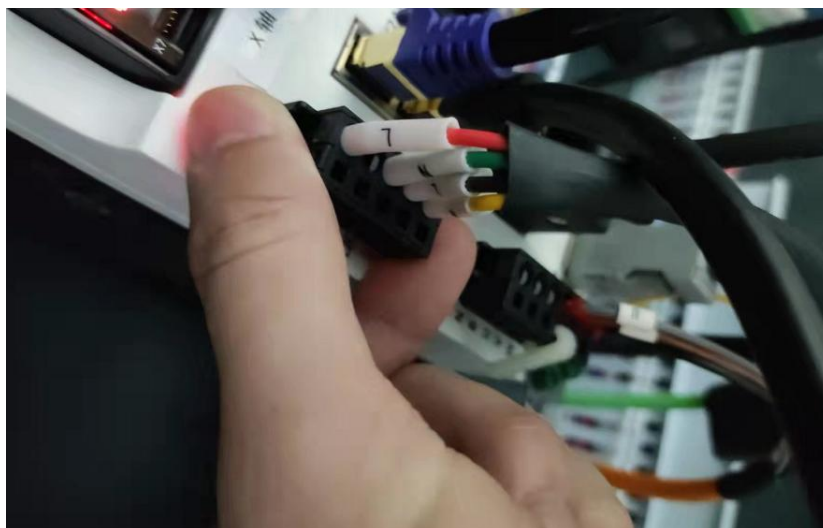
After modifying the parameters, the drive needs to be powered off and restarted. At this time, it will alarm for absolute value protection. then open

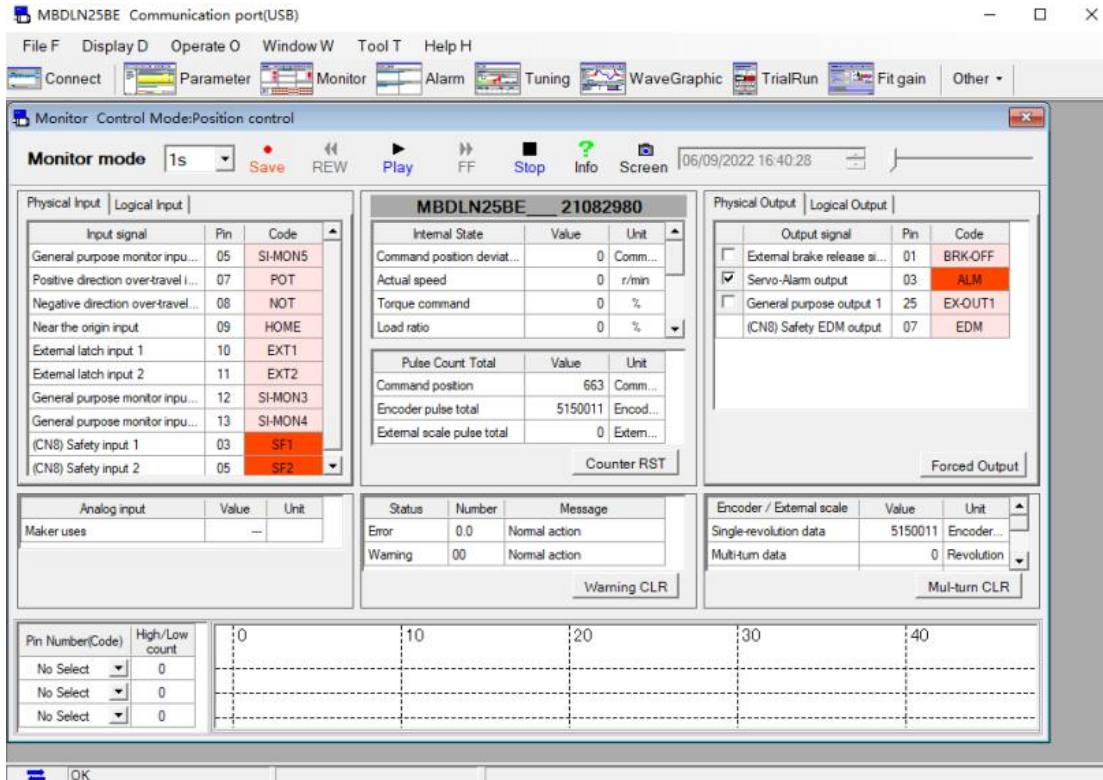

17. You can see the display in the lower left corner: Drive absolute system shutdown abnormal protection Click on the monitor

**S7020T Terminal Insertion Machine Use's Manual**

The screenshot shows the 'Monitor mode' interface for the MBDLN25BE machine. The window title is 'MBDLN25BE Communication port(USB)'. The interface includes a menu bar (File F, Display D, Operate O, Window W, Tool T, Help H) and a toolbar with buttons for Connect, Parameter, Monitor, Alarm, Tuning, WaveGraphic, TrialRun, Fit gain, and Other. The main display area is titled 'Monitor Control Mode: Position control' and shows the following data:

Physical Input			Logical Input		
Input signal	Pin	Code	Input signal	Pin	Code
General purpose monitor input...	05	SI-MON5			
Positive direction over-travel i...	07	POT			
Negative direction over-travel...	08	NOT			
Near the origin input	09	HOME			
External latch input 1	10	EXT1			
External latch input 2	11	EXT2			
General purpose monitor input...	12	SI-MON3			
General purpose monitor input...	13	SI-MON4			
(CN8) Safety input 1	03	SF1			
(CN8) Safety input 2	05	SF2			

MBDLN25BE 21082980		
Internal State	Value	Unit
Command position deviat...	0	Comm...
Actual speed	0	r/min
Torque command	0	%
Load ratio	0	%

Physical Output			Logical Output		
Output signal	Pin	Code	Output signal	Pin	Code
<input type="checkbox"/> External brake release si...	01	BRK-OFF			
<input checked="" type="checkbox"/> Servo-Alarm output	03	ALM			
<input type="checkbox"/> General purpose output 1	25	EX-OUT1			
(CN8) Safety EDM output	07	EDM			

Pulse Count Total		
Value	Unit	
Command position	663	Comm...
Encoder pulse total	5150011	Encod...
External scale pulse total	0	Extern...

Status	Number	Message
Error	0.0	Normal action
Warning	00	Normal action

Encoder / External scale		
Value	Unit	
Single-revolution data	5150011	Encod...
Multi-turn data	0	Revolution

  

Pin Number(Code)	High/Low count
No Select	0
No Select	0
No Select	0

18. Then click to clear warnings, clear multi-turn counts, reset the sum, and finally power off and restart the drive to adjust the drive parameters. Similarly, the Y-axis, Ra-axis and Rb-axis operate the same.

### 5.Reset of drive and motion card

#### 1. Software location

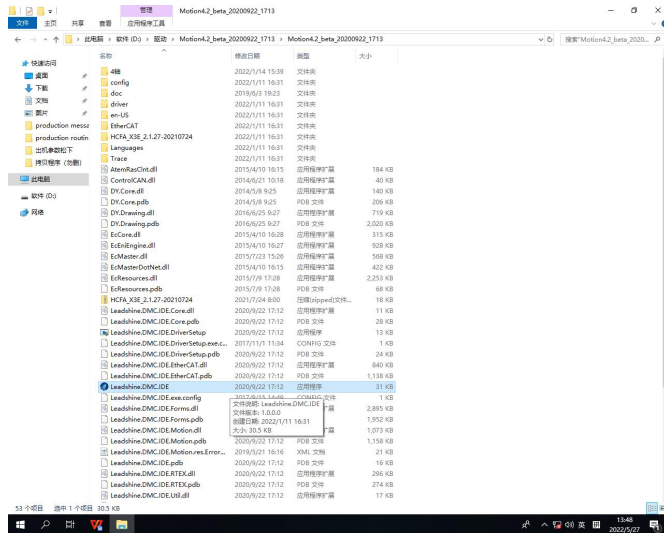

#### 2. Network connection diagram

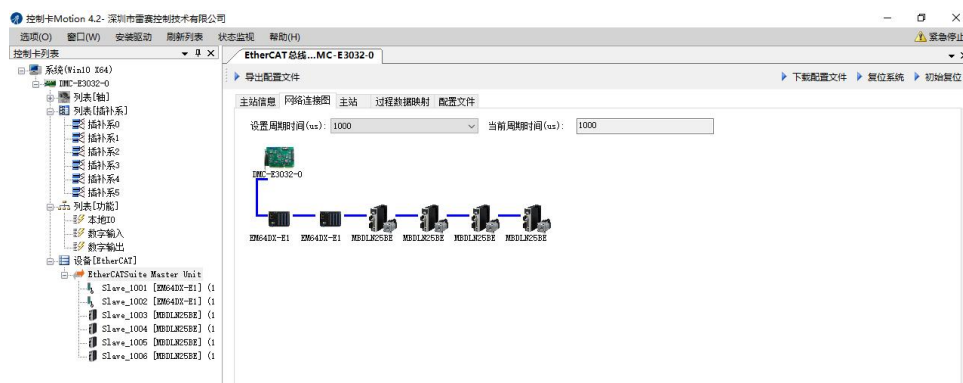

#### 3. Reset the drive and its motion card



4. Generally, the driver has a simple alarm, and the alarm can be cleared by resetting here.

## 6. Servo drive troubleshooting

Alarm code	Alarm content	Solution
11	Insufficient voltage protection of control power supply	Check the input supply voltage
12	Over voltage protection	Equipped with power supply with correct voltage
13	Insufficient mains voltage protection	Measure the phase voltage between L1, L2, L3 terminals
14	overcurrent protection	Check motor cables to make sure U, V, W are not shorted
15	Overheating protection	Reduce ambient temperature/extend acceleration/deceleration time
16	Overload protection	Readjust the gain
18	Regenerative discharge overload protection	Set the value of Pr0.16 to 2
21	Encoder communication abnormal protection	Correct wrong wiring
23	Encoder communication data abnormal protection	Check the encoder line connection plug
24	Excessive position deviation protection	Set Pr0.13 and Pr5.22 to the maximum
25	Hybrid control position deviation is too large protection	Check the connection between the motor and the load
26	Overspeed protection	Reduce motor speed
27	Command pulse frequency division and multiplication abnormal protection	Set Pr5.23 to less than 1000
29	Deviation Counter Overflow Protection	Set Pr0.13 and Pr5.22 to the maximum
36	EEPROM parameter abnormal protection	reset all parameters
37	EEPROM verification code abnormal protection	Servo drive may be faulty (send to factory for overhaul)

## 7. Maintenance and adjustment and common fault handling

### 7.1 Maintenance

Maintenance item	Maintenance content
Daily maintenance	1. Every day at work, check whether the air pressure is normal (0.5-0.6Mpa)
	2. Get off work, clean the dust of the machine and the excess grease leaking out
Monthly maintenance	1. Wipe clean all polished rods, screw rods, linear slides with a rag and re-spray with butter
	2. Check the wear and deformation of the press cover and clinching mold, replace if necessary
	3. Check whether the pneumatic components (solenoid valve, cylinder, etc.) are working properly
	4. Check the connection status of the floating joints, whether there is any looseness or gaps, and replace them if necessary
	5. Check the tension, length, and wear of all belts, and adjust them, taking care not to make them sticky
	6. Clean all tape feeder and tracks
	7. Check whether the drive shafts and bearings are worn at all parts and replace them
	8. Check the center position of each head, the alignment of the clinching mold and the head, and adjust if there is any deviation
	9. Check whether the circuit has leakage or aging
Yearly maintenance	1. Check all solenoid valves and cylinders, measure their speed and response, and adjust
	2. Check the coordination of all motors, servo actions and screw rods, whether there is any looseness of the screw rods
	3. Check whether the main air valve, muffler, air pipe and other air circuit components are normal, replace if necessary
	4. Clean the host computer and check whether the fan is normal
	5. Check whether all the exhaust fans on the machine shell are normal and clean
	6. Check whether all the signals in the equipment status are normal and whether the sensors are good
	7. Check the function of camera recognition, correct the deviation ratio of the part hole size, and readjust if necessary

## S7020T Terminal Insertion Machine Use's Manual

	8. Dismantle the feeder for maintenance and redo standard debugging
	9. Use slow motion video to take pictures of the insertion movements of each head and observe its coordination. If necessary, adjust the parameters of each axis and the air pressure of the cylinder.

## 7.2 common faults and handling methods

Undesirable phenomena	Analyze the cause	processing method
Poor insertion	1. bad picking of clamping head	Check whether the clamp is normal, loose or damaged
	2. inaccurate insertion coordinates	Coordinate correction, head offset, fixed PCB
	3. no parts detected	Adjust the clearance between the upper and lower head and PCB board, check whether the detection line is open circuit, or whether the position of the bottom mold is adjusted properly
PCB leakage	1. short circuit of bottom formwork	Check whether the insulating plate and screw insulating sleeve are damaged
	2. detection line short circuit	Use a multimeter to measure whether the voltage of the detection line at the end of the bottom mold is normal, whether the detection line is short circuited, and whether the line is installed properly. Whether the pressing head of the switch contacts the four legs of the part.
Blocking and feeding are not smooth	1. poor track feeding	Adjust the alignment and parallelism between the discharge port of the vibrating disk and the feed port of the long feeding track
	2. poor feeding track	Check whether the long track is aligned with the X slider, and whether the X slider is aligned with the short track; whether the fixed part is loose, and whether the movable part is worn; replace and adjust as the case may be
	3. The material channel is scratched unevenly or has oil and sundries	Polish with sandpaper and clean with clean cloth
	4. quality problems of materials	Remove defective materials or replace
	1. inaccurate insertion	Use vision system to correct coordinates, head

## S7020T Terminal Insertion Machine Use's Manual

Bad bent feet	coordinate	offset and fix PCB
	2.The upper and lower heads are not in the correct central position	Adjust the base and its centering position according to the clamping head
	3.the gap between the upper and lower head and PCB is not suitable	Adjust the height of insertion head and bottom mold
Servo alarm	1.foreign matter stuck on the front axle	Remove foreign matters
	2 server alarm	Remove the alarm on the server, click the re read servo motor parameter in the upper right corner of the main page, and return to zero
Press start switch does not work	1.Power supply problems	Check the power supply, voltage and circuit continuity
	2.Gas supply problems	Check air valve and air pressure
	3.Abnormal detection of safety sensor	Open the device status in the software to check the sensor status
	4.Emergency stop switch on	Close
	5.Others	Refer to the displayed fault information
Visual system cannot be corrected	1.The camera cable is broken or in poor contact	Change the line or clean the interface
	2.Inappropriate light source intensity and camera identification parameters	Adjust the light source intensity and reset the camera parameters in the machine parameters of the software
	3.Foreign matters in camera and PCB calibration hole	Remove foreign matters or replace with a good PCB

Undesirable phenomena	Analyze the cause	processing method
Track transport PCB board, PCB transport timeout	1.Track width not suitable	Adjust track width
	2.The left and right tracks are not parallel to the workbench tracks	Adjust parallel
	3.The height difference between left and right rails and workbench rails is too large	Adjust the height of left and right rails
	4.Track is not smooth or deformed	To polish, correct, or replace with sandpaper
	5. The pressing plate cylinder moves too fast or too slowly, the action is not coordinated, and the PCB is not	Adjust the pressure plate cylinder throttle valve to a stable state

## S7020T Terminal Insertion Machine Use's Manual

	delivered in time	
	6.Conveyor motor speed too slow	Adjust motor speed or replace
Workbench Poor PCB positioning	1.The positioning fixture is not standardized or adjusted properly	Use the proper positioning jig to adjust according to the correct steps
	2.PCB in place sensing abnormal	Adjust the position of the sensor in place or replace it
	3.PCB positioning sensor is too low or too high or its sensor is abnormal	Adjust the height of the sunshade or replace the sensor
The upper and lower shelves do not reset after PCB exchange	1.Air pressure of left and right rail cylinders is too low	Check whether the air supply pressure and its solenoid valve are normal
	2.The position of low position sensor of left and right track cylinder is not suitable, unable to sense normally	Adjust the position of the sensor to make it sense normally
	3.There are sundries blocking the lifting space of left and right tracks	Clean, lubricate, reset with I / O drive
PCB scratched or damaged	1.The gap between insertion head, bottom die and PCB is too small	Adjust the height of insertion head and bottom mold
	2.The action of insertion head and bottom mold insertion is inconsistent	Adjust the cushion of cylinder valve at the cylinder base of insertion head
	3.Poor PCB positioning	Check whether the positioning fixture is suitable and whether the positioning position is offset
	4.Program coordinate offset	Recalibrate using the visual system

### 7.3 The adjustment method of each action part of the machine:

#### 7.3.1 adjustment of insertion head and pressing rod

1. When the feeder feeds to the lower end of the pressing rod, the switch floats up and down to about 1mm in the pressing rod, and both ends can be adjusted by floating air connection.

## S7020T Terminal Insertion Machine Use's Manual

2. The position from the insertion head to the PCB board is controlled by the travel adjusting nut at the top of the insertion cylinder.
3. The air volume regulating valves at the upper and lower ends of the insertion cylinder can adjust the speed of the insertion head rising and dropping respectively.
4. The axial adjustment seat of the press bar is used to adjust the center position of the press bar when inserting the PCB.
5. Loosen the four screws on the front of the feeder to fine tune the left and right, and align the adjustment with the left and right of the insertion head.
6. There are four screws at the bottom of the feeder that can be loosened to adjust the feed forward movement of the feeder, which is used to adjust the feeding position with the insertion head.

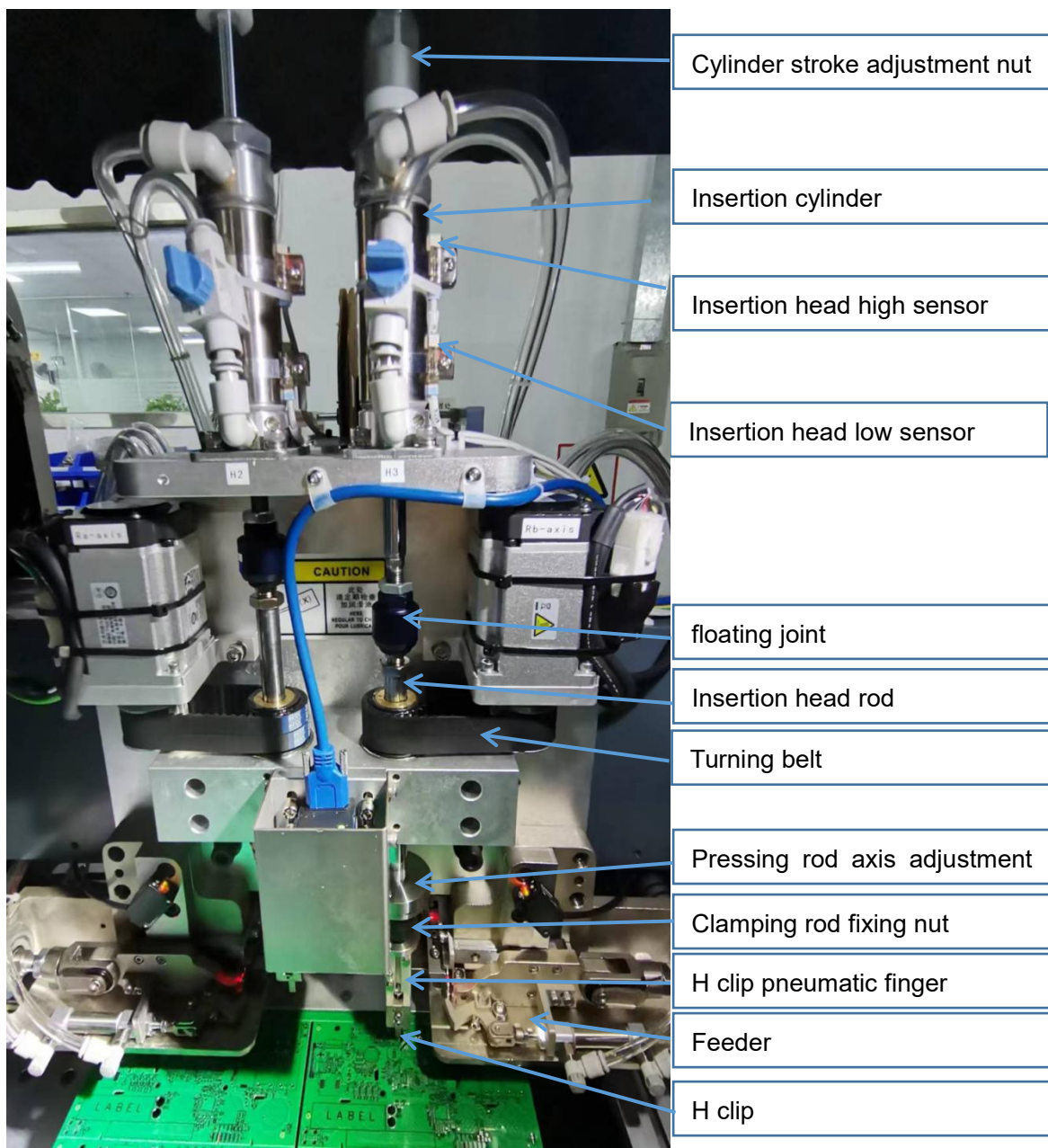

7.3.2 center adjustment of insertion head It is better to move the program to a point where insertions are needed It is a + 90 degree insertion angle to send a part to the press. Clamp on the head and put down the head, subject to the head parts. First correct the + 90 degree coordinate, so that the parts can be inserted smoothly. Insert into the plate hole, turn the head to - 90 degrees, check as above 4 2 Coordinates. It can also insert parts into the same plate hole, i.e. the center Bit accuracy. If there is deviation, put down the head and adjust the right side Fig. (loosen the fixing screw so that the upper and lower parts are aligned Connect the disc to reach a gap of 0.2mm, and adjust the upper part Four adjusting screws to return half of the deviation The pressing head can smooth the parts at + 90 degree and - 90 degree Insert it into the center of the head in the hole of the part on the PCB board The base and feeder can only be adjusted after correction.

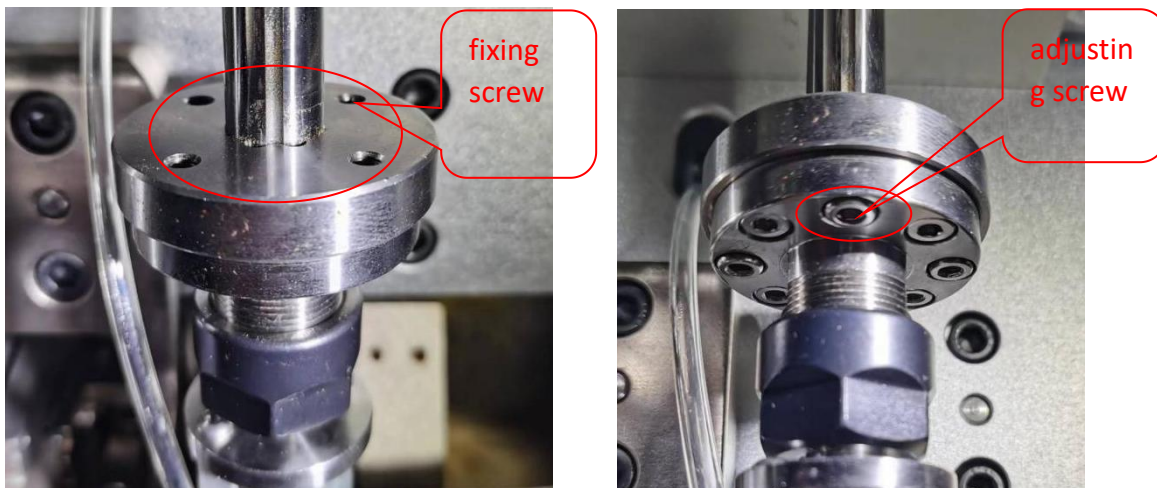

### 7.3.3 alignment of the base and insertion head.

After the center position of the insertion head is adjusted, the center position of the base can be adjusted, the base of the current head is raised, and the air pressure of the head is manually turned off, so that the pressing head with the parts clamped can be manually lowered, and the fixing screw of the base can be adjusted by loosening the base. The front, back, left and right positions of the bottom mold make the part feet on the pressing head align with the bent feet on the top surface of the bottom mold. When the two corresponding angles (with a difference of 180 degrees) are not centered,

As shown below image:

The red circle is the adjusting screw, and the square is the fixing screw. Loosen the fixing screw and adjust the adjusting screw so that the base and the pressing head are centered at the corresponding two angles.

## S7020T Terminal Insertion Machine Use's Manual

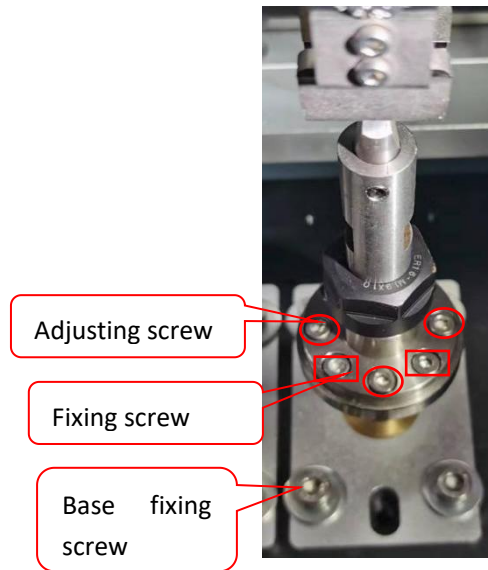

### 7.3.4 adjustment of feeder

#### 1. Feed front adjustment:

Active state, i.e. cylinder end point: click the "feeding drive" of this head in the equipment state to make the feeding cylinder move to the end point; adjust the front limit nut of the feeding cylinder to make the material clamped by the clamping cylinder just send to the center of the pressing head clamp. If there is any difference between the left and right, loosen the fixing screw of the feeder to fine tune the left and right.

#### 2. Position adjustment after feeding:

Stop state, starting point of feeding cylinder: adjust the connecting rod of feeding cylinder, stop position of integrated small or elongated cylinder, so that the clamping cylinder can clamp the first material on the feeding track. The adjustment of the front and rear position of the feeder does not have a reference sequence, and the adjustment is made according to the actual situation.

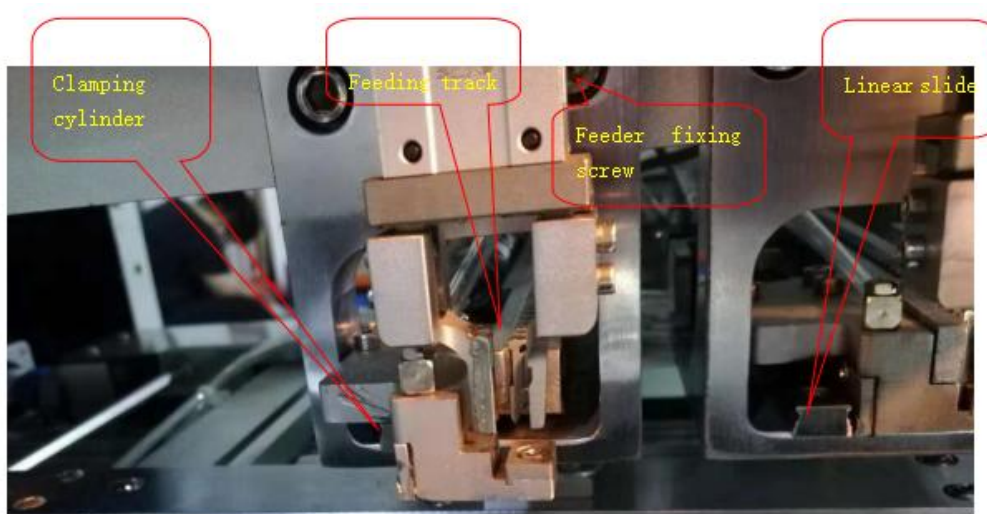

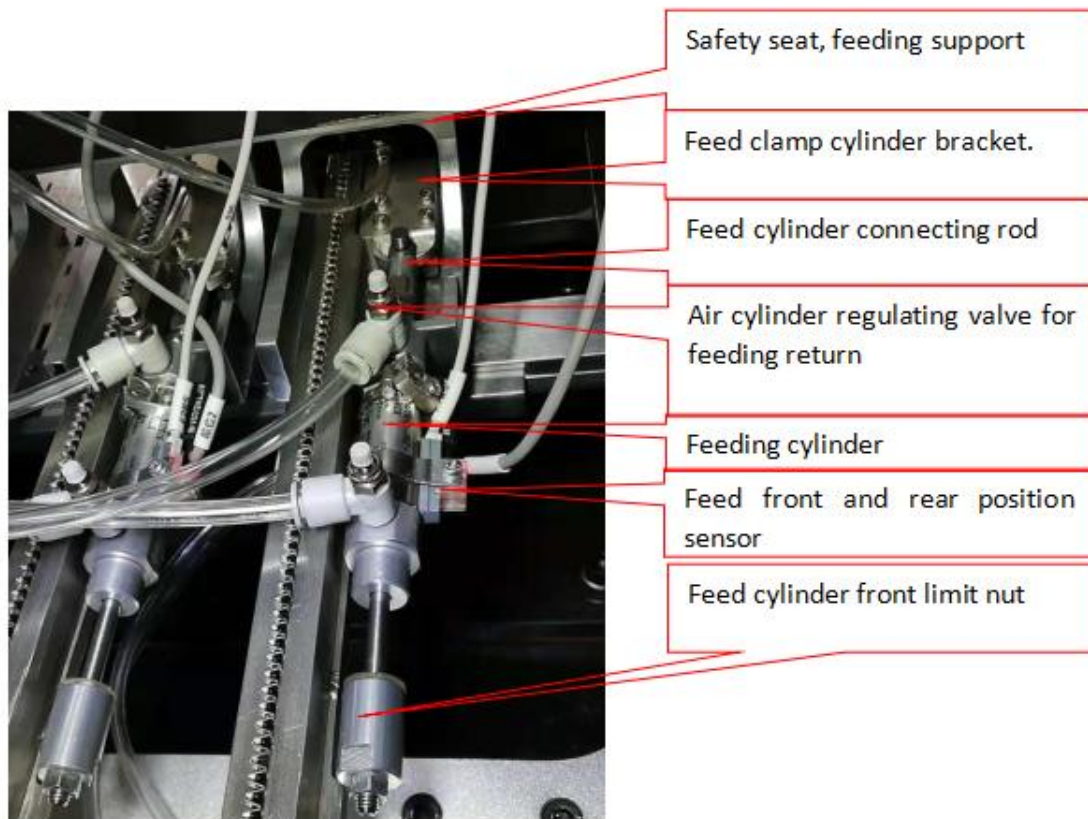

### 7.3.5 adjustment of vibration disk and track

After the front and back position of the feeding cylinder is determined, the position of the track is fixed:

1. The track height is controlled by adjusting the four corner fixing screws of the support plate under the flat vibration,
2. By adjusting the track fixing screws on the flat vibration, the front and rear positions of the track can be adjusted. Fix the position of the vibrating plate after the position of the track is determined: This machine is a plate with two tracks. The outlet on the plate must correspond to two flat tracks. After alignment, fix the foundation cup of the vibration plate.

S7020T Terminal Insertion Machine Use's Manual



- Flat vibration support plate fixing screw
- Track fixing screw
- Interface between track and vibration plate

7.3.6 Side view of feeding components

Please select the corresponding components(Riveting column/Terminal) for reference in the following pictures

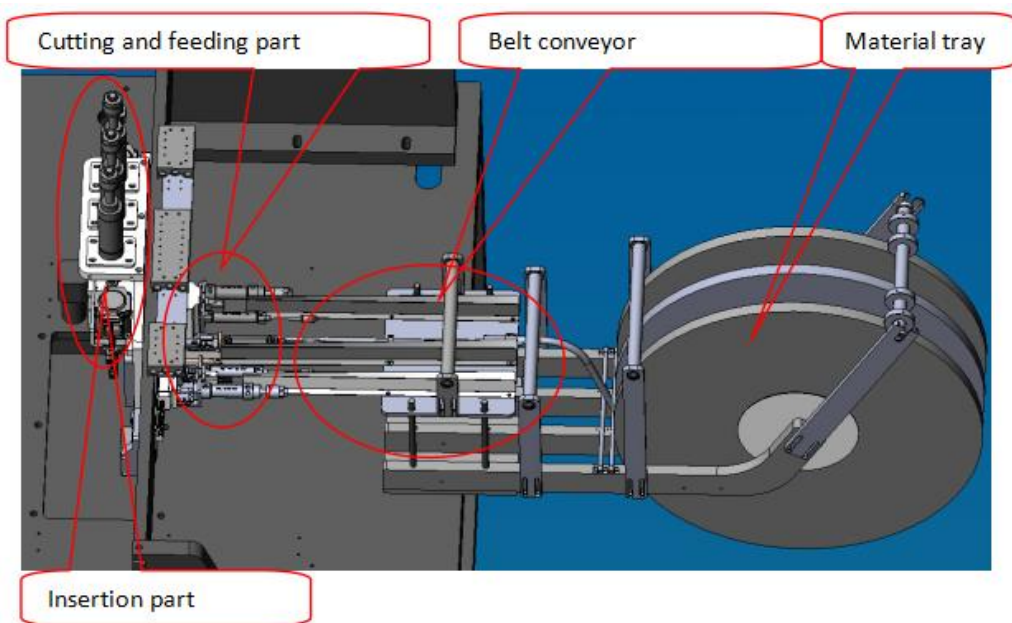

## S7020T Terminal Insertion Machine Use's Manual

Riveting column feeder position: the riveting column feeding mode is right in and left out (facing the front of the equipment). The feeding gear transmits the braided riveting column one at a time to the front of the feeding clamp through the step motor, and the feeding cylinder sends the material forward to the middle of the H clamp. Pay attention to the position of the stop block of the gate, which can effectively pull the riveting column at the first position, so that the feeding clamp can be clamped when cutting the foot

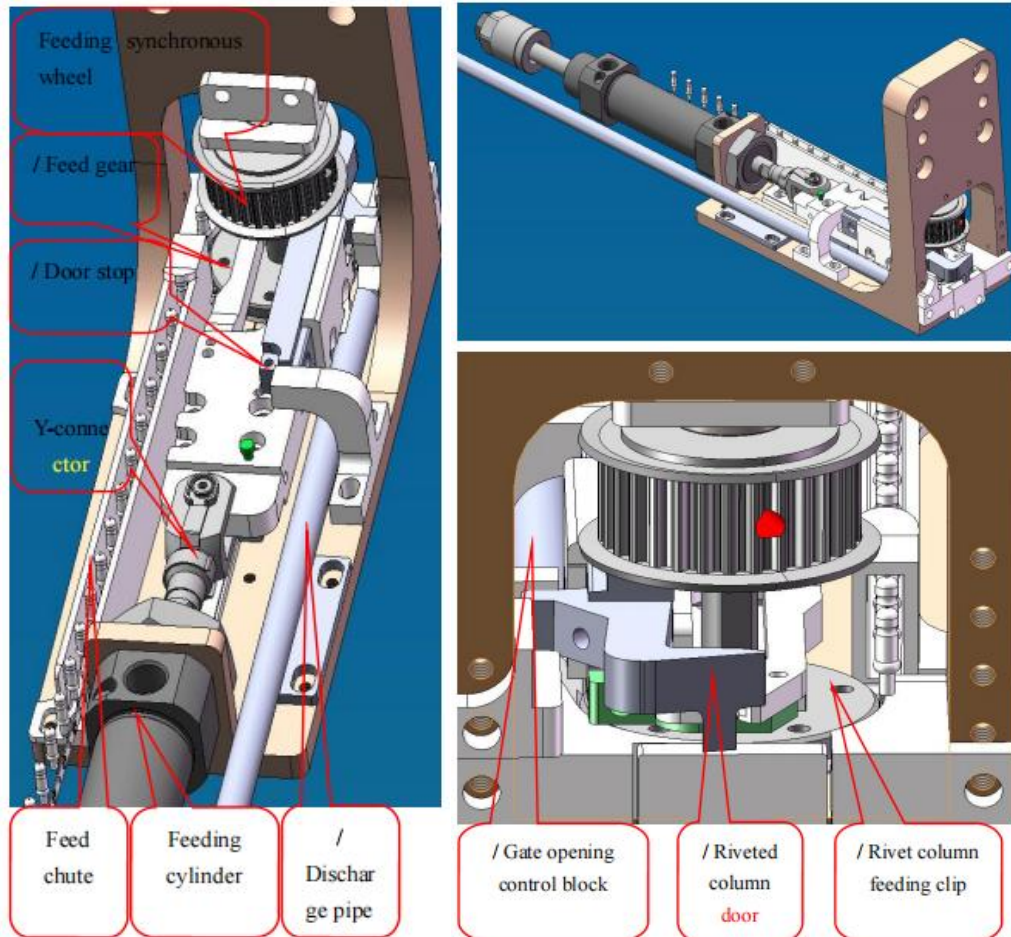

Feeding position of terminal insert:

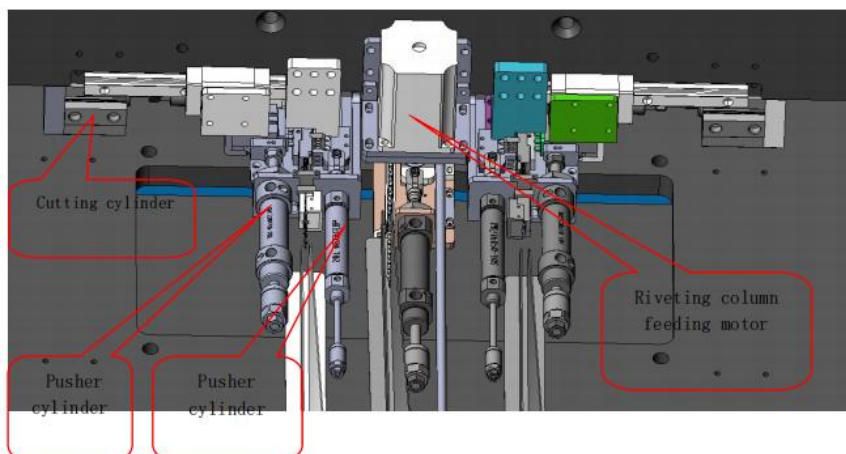

## S7020T Terminal Insertion Machine Use's Manual

When installing the insert, first turn off the air supply of the feeding part, push the cutting cylinder to the front to counter the fixed knife, and then push the feeding slot of the insert to the front to counter the cutting knife. At this time, the material belt is just stuck in the feeding slot and can't be backed up

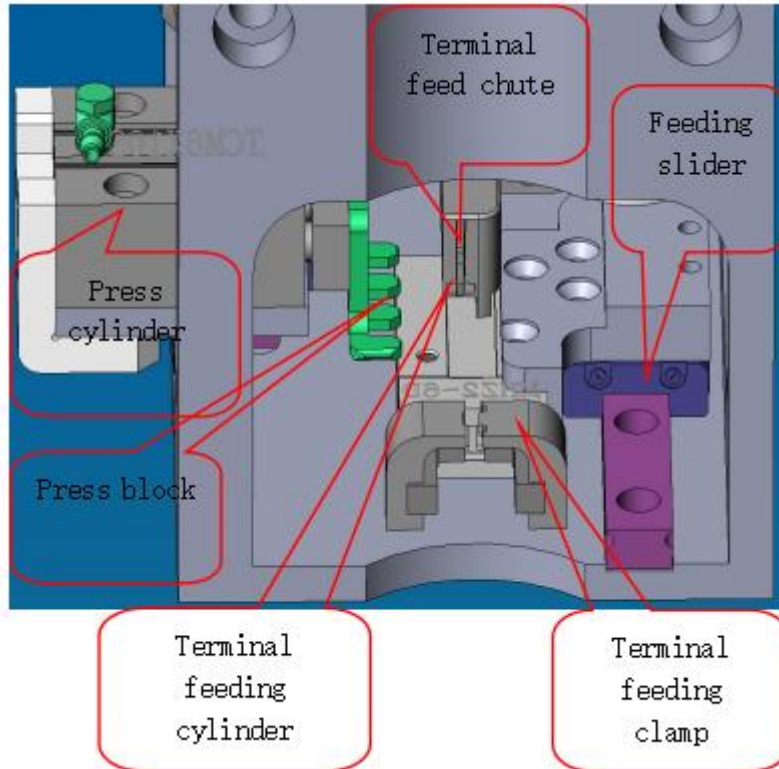

Feeding action:

- ① press the material cylinder to drive and press the material band foot,
- ② push the material cylinder forward to push a grid of material, send the material to the material feeding clamp position,
- ③ drive the cutting knife to cut off and counter the first material sent out,
- ④ feed the clamp to clamp the cut material foot,
- ⑤ return the cutting knife, Return the pressing cylinder.
- ⑥ drive the feeding cylinder to send the clamped material to the middle of the insertion head.
- ⑦ return the pushing cylinder.
- ⑧ clamp the upper part of the material by the insertion head.
- ⑨ loosen the feeding clamp.
- ⑩ return the feeding cylinder

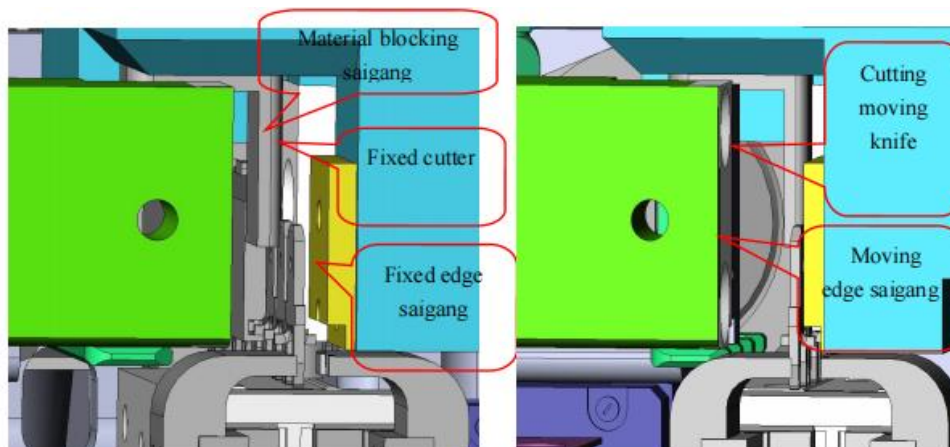

## 7.4 Introduction of customized terminal insertion machine

### Insetion part:

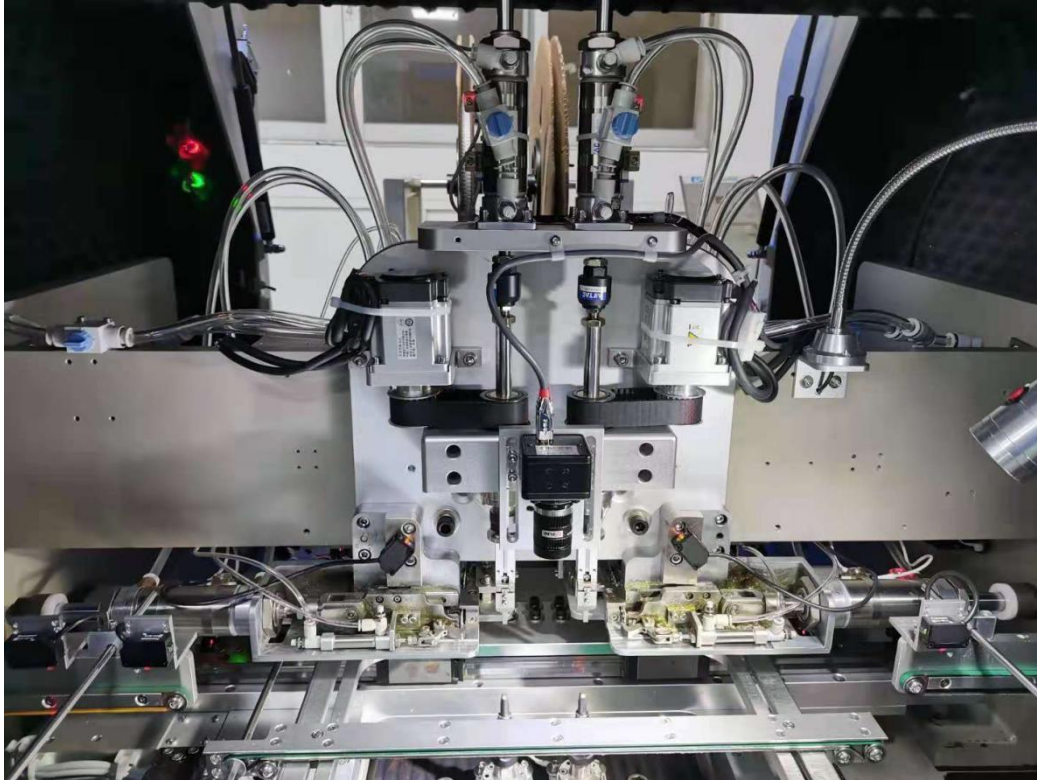

### Feeding part:

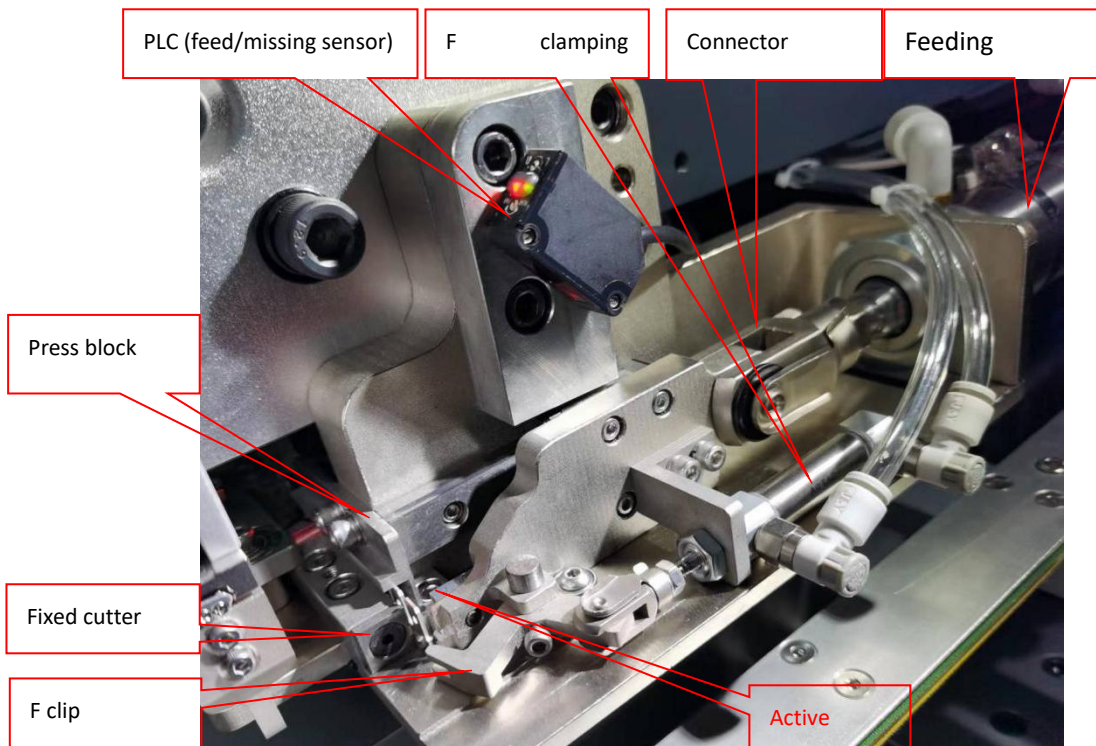

S7020T Terminal Insertion Machine Use's Manual

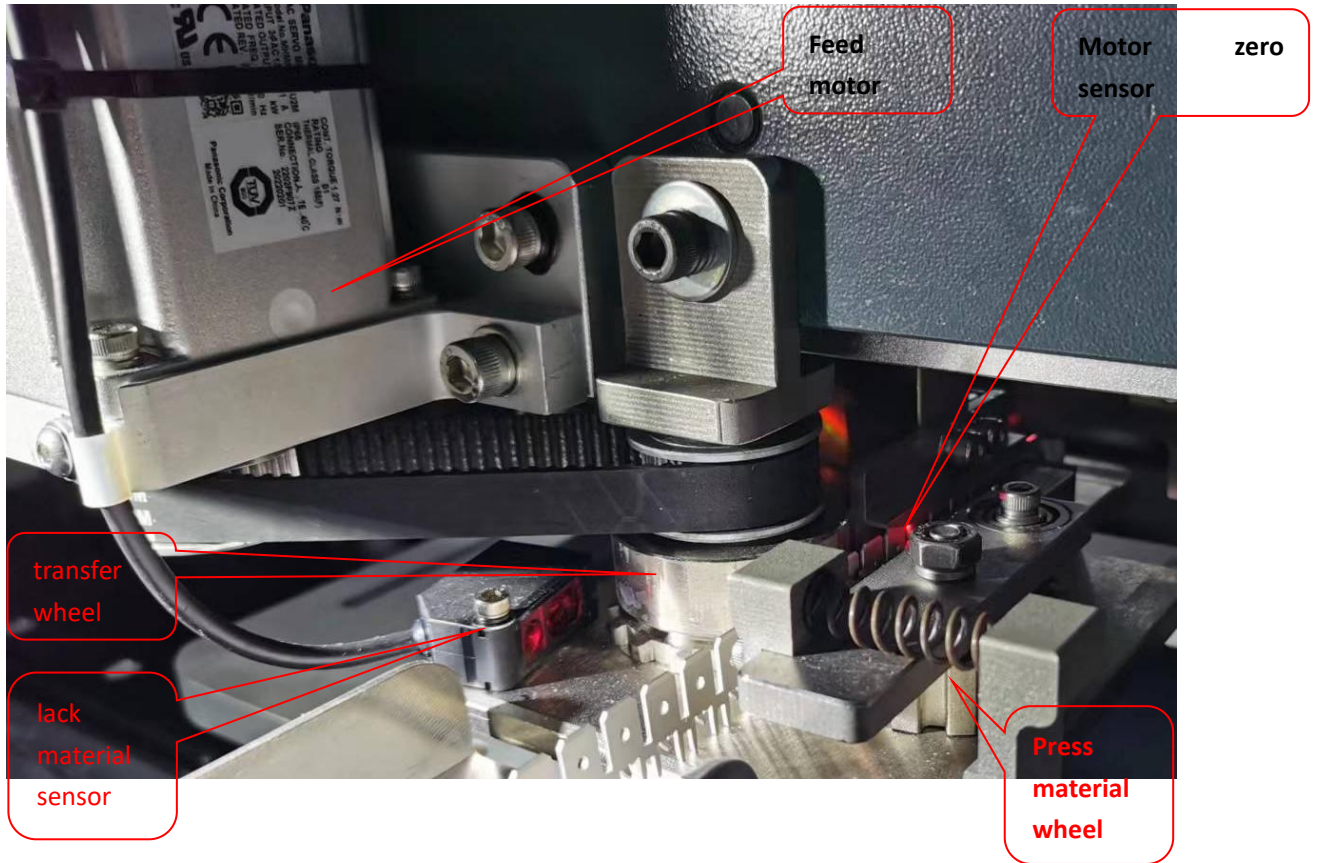

## S7020T Terminal Insertion Machine Use's Manual

Place the terminal material tray on the material rack, the insert piece passes through the material transfer chute, pulls open the pressing material wheel, lets the insert piece pass through the material transfer wheel, and enters under the pressure block, and the two feet of the insert piece just snap into the protruding teeth of the transfer wheel. superior. Drive the feeding cylinder to feed-return action, so that the insert piece is transferred to the front end of the main pusher block to complete the loading. The material is clamped by the F material clamp (picture 1), the feeding cylinder is pushed forward to cut the material tape through two cutters, and the first material is sent to the insertion head material clamp (picture 2). Adjust the limit nut at the end of the feeding cylinder so that the insert piece is just pushed in the middle of the groove of the H clip. Be careful not to hit the H clip when the main pusher block is adjusted. (Picture 3) At the same time, adjust the height of the H clip by adjusting the position of the floating joint connected to the H cylinder. Match the delivery.

picture 1



F material clamp to clamp the material

Cylinder stroke adjustment F clip position

picture 2

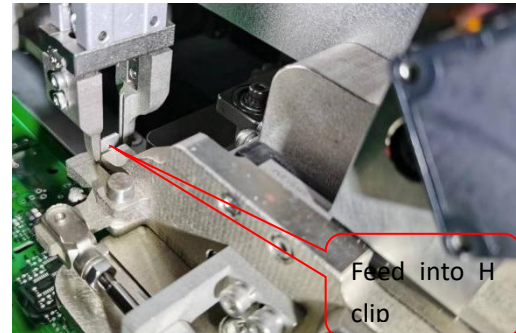

Feed into H clip

picture 3

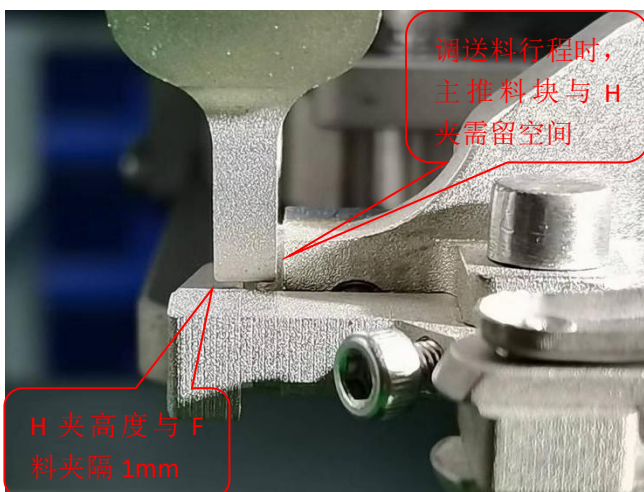

H 夹高度与 F 料夹隔 1mm

调送料行程时，主推料块与 H 夹需留空间



H 夹取料高度调节



## S7020T Terminal Insertion Machine Use's Manual

Card No. 1: EM64dx-E1-1 - (back on the right side of the fuselage beam)

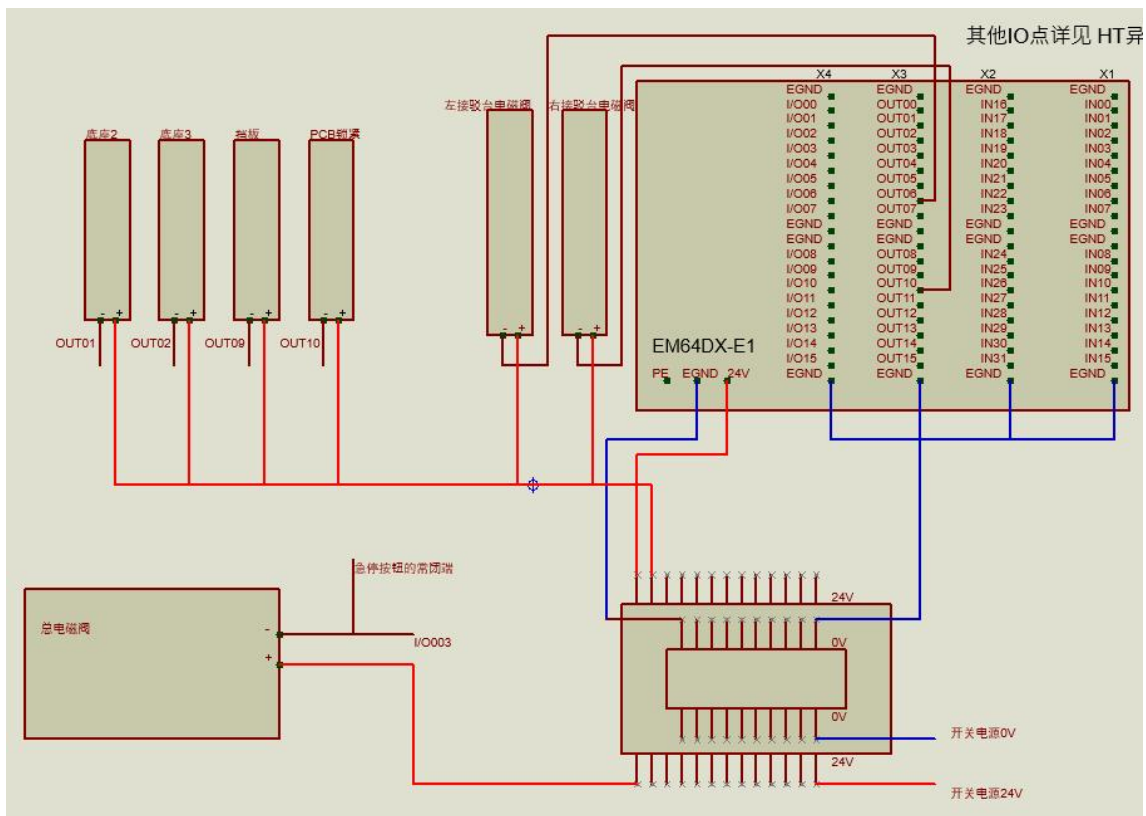
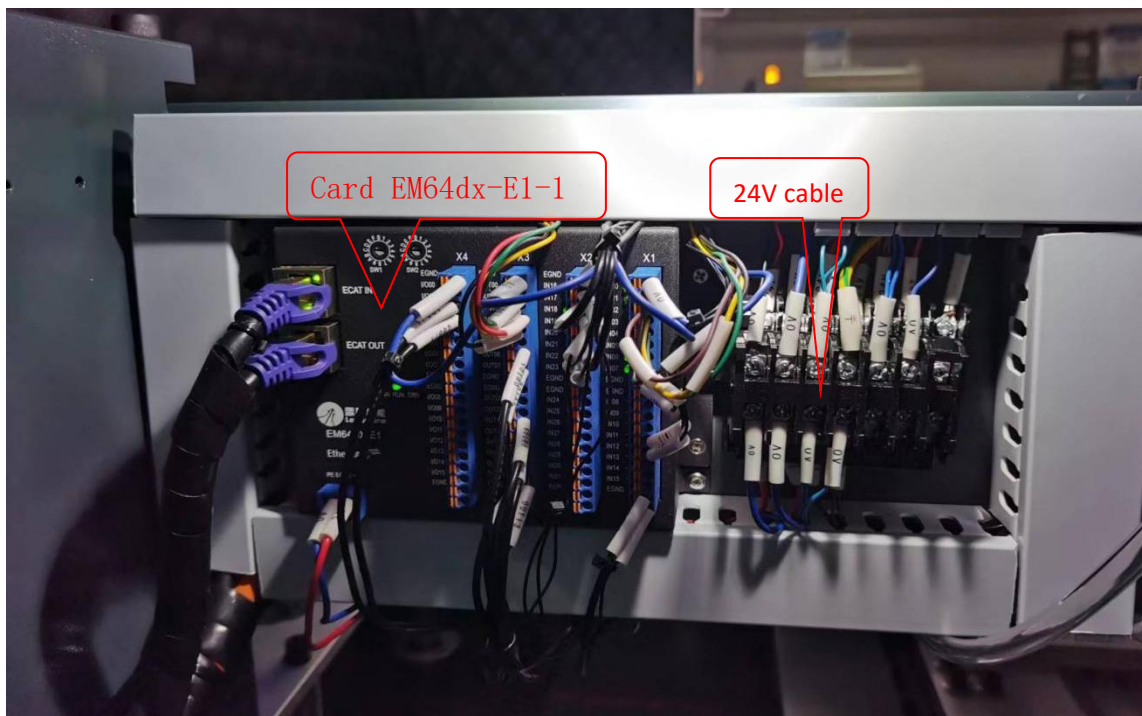

## S7020T Terminal Insertion Machine Use's Manual

Card No. 2: EM64dx-E1-2(in the lower door on the left side in front of the fuselage)

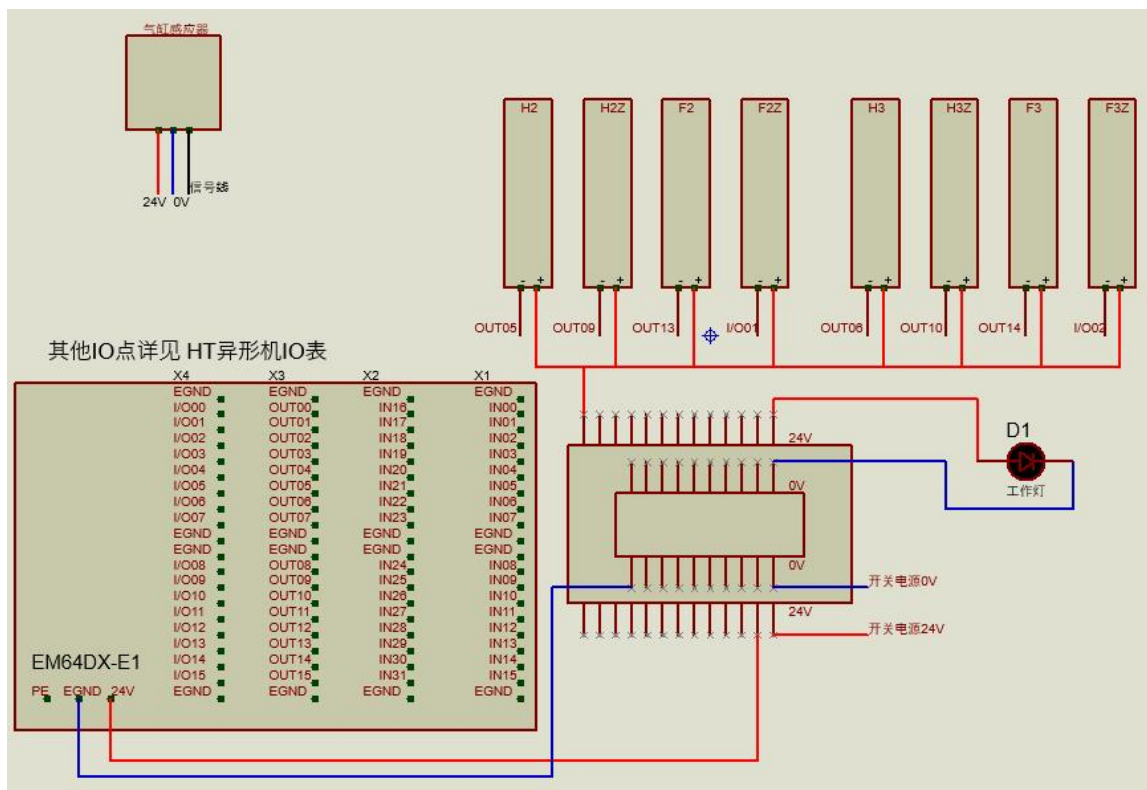
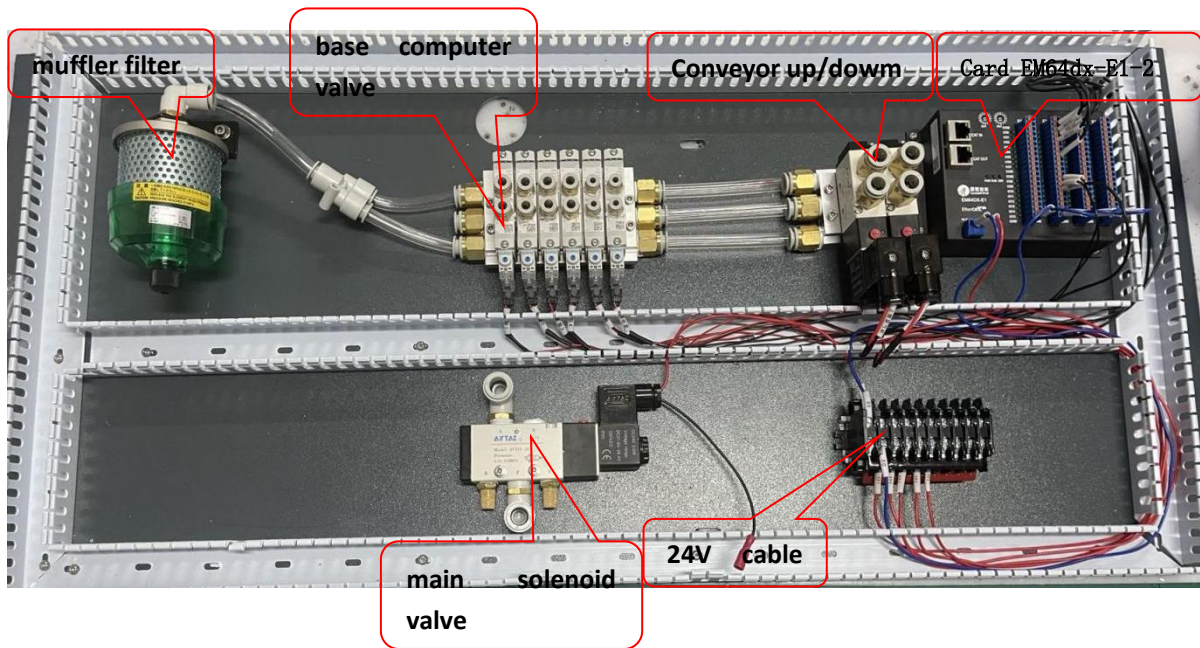

## S7020T Terminal Insertion Machine Use's Manual

Card 1: EM64dx-E1-1									
Input signal			Axis number: X axis 0, Y axis 1, RA axis 2, Q axis 3, RB axis 4				Output signal		
No	P	I/O	Part	Valid level	No	P	I/O	Part	Valid level
1		EGND			41		EGND		L
2		IN00	Emergency stop switch	H	42		OUT00	green light	L
3		IN01	start	L	42		OUT01	yellow light	L
4		IN02	stop	L	44		OUT02	Red light	L
5		IN03	security door control	L	45		OUT03	buzzer	L
6		IN04	Raster alarm	L	46		OUT04	head 1 cylinder(H1)	L
7		IN05	Head 1 high position(H1UP)	L	47		OUT05	head 2 cylinder(H2)	L
8	X 1	IN06	Head 2 high position(H2UP)	L	48	X 3	OUT06	head 3 cylinder(H3)	L
9		IN07	Head 3 high position(H3UP)	L	49		OUT07	head 4 cylinder(H4)	L
10		EGND			50		EGND		
11		EGND			51		EGND		
12		IN08	Head 4 high position(H4UP)	L	52		OUT08	Head 1 gripping material	L
13		IN09	Head 1 low position(H1DN)	L	53		OUT09	Head 2 gripping material(H1Z)	L
14		IN10	Head 2 low position(H2DN)	L	54		OUT10	Head 3 gripping material	L
15		IN11	Head 3 low position(H3DN)	L	55		OUT11	Head 4 gripping material	L
16		IN12	Head 4 low position(H4DN)	L	56		OUT12	Feeding 1 cylinder(F1)	L
17		IN13	Feed 1 in place	L	57		OUT13	Feeding 2 cylinder(F2)	L
18		IN14	Feed 1 reset	L	58		OUT14	Feeding 3 cylinder(F3)	L
19		IN15	Feed 2 in place	L	59		OUT15	Feeding 4 cylinder(F4)	L
20		EGND			60		EGND		
21		EGND			61		EGND		
22		IN16	Feed 2 reset	L	62		I/O00	Feed clip 1	L
23		IN17	Feed 3 in place	L	63		I/O01	Feed clip 2	L
24		IN18	Feed 3 reset	L	64		I/O02	Feed clip 3	L

## S7020T Terminal Insertion Machine Use's Manual

25		IN19	Feed 4 in place	L		65		I/O03	Feed clip 4	L
26		IN20	Feed 4 reset	L		66		I/O04	Pin Shaping 1	L
27		IN21	Material inspection 1	L		67		I/O05	Pin Shaping 2	L
28		IN22	Material inspection 2	L		68		I/O06	Pin Shaping 3	L
29		IN23	Material inspection 3	L		69		I/O07	Pin Shaping 4	L
30		EGND				70		EGND		
31	X	EGND				71	X	EGND		
32	2	IN24	Material inspection 4	L		72	4	I/O008	Feed back to zero	
33		IN25	Vacuum detection 1	L		73				
34		IN26	Vacuum detection 2	L		74				
35		IN27	Vacuum detection 3	L		75				
36		IN28	Vacuum detection 4	L		76				
37		IN39	null			77				
38		IN30	null			78				
39		IN31	null			79				
40						80				

**Card 2: EM64dx-E1-2**

Card 2: EM64dx-E1-2									
Input signal			Axis number: X axis 0, Y axis 1, RA axis 2, Q axis 3, RB axis 4				Output signal		
No	P	I/O	Part	Valid level	No	P	I/O	Part	Valid level
1		EGND			41		EGND		L
2		IN00	Left conveyor high (cylinder)	L	42		OUT00	base 1	L
3		IN01	Left conveyor low	L	42		OUT01	base 2	L
4		IN02	Front machine has PCB	L	44		OUT02	base 3	L
5		IN03	Inside the left conveyor(sensor)	L	45		OUT03	base 4	L
6		IN04	Outside the left side conveyor	L	46		OUT04	camera light source	L
7	X	IN05	right side conveyor is high limit	L	47	X	OUT05	This machine requires board	L
8	1	IN06	right side conveyor is low limit	L	48	3	OUT06	Left conveyor cylinder	L
9		IN07	Inside the right side conveyor	L	49		OUT07	left conveyor motor	L
10		EGND			50		EGND		

## S7020T Terminal Insertion Machine Use's Manual

11		EGND			51		EGND		
12		IN08	Outside the right side conveyor	L		52	OUT08	Worktable motor	L
13		IN09	Base 1 high limit	L		53	OUT09	baffle	L
14		IN10	Base 2 high limit	L		54	OUT10	PCB locking	L
15		IN11	Base 3 high limit	L		55	OUT11	Right side conveyor cylinder	L
16		IN12	Base 4 high limit	L		56	OUT12	Right side conveyor motor	L
17		IN13	Base 1 low limit	L		57	OUT13	This machine has board	L
18		IN14	Base 2 low limit	L		58	OUT14	Clinching 1	L
19		IN15	Base 3 low limit	L		59	OUT15	Clinching 2	L
20		EGND				60	EGND		
21		EGND				61	EGND		
22		IN16	Base 4 low limit	L		62	I/O00	Clinching 3	L
23		IN17	Insertion Detection 1	L		63	I/O01	Clinching 4	L
24		IN18	Insertion Detection 2	L		64		null	
25		IN19	Insertion Detection 3	L		65		null	
26		IN20	Insertion Detection 4	L		66		null	
27		IN21	Air pressure detection	H		67		null	
28		IN22	The machine behind requests the Board	L		68		null	
29		IN23	board in place	L		69		null	
30	X	EGND				70		null	
31	2	EGND				71		null	
32		IN24	Press the board signal	L		72		null	
33		IN25	parking signal	L		73		null	
34		IN26	X+ Limit	L		74		null	
35		IN27	X- Limit	L		75		null	
36		IN28	Y+ Limit	L		76		null	
37		IN29	Y- Limit			77		null	
38		IN30	null			78		null	
39		IN31	null			79		null	
40						80		null	

## 8. Introduction to explosion diagram

### 8.1 Insertion head part

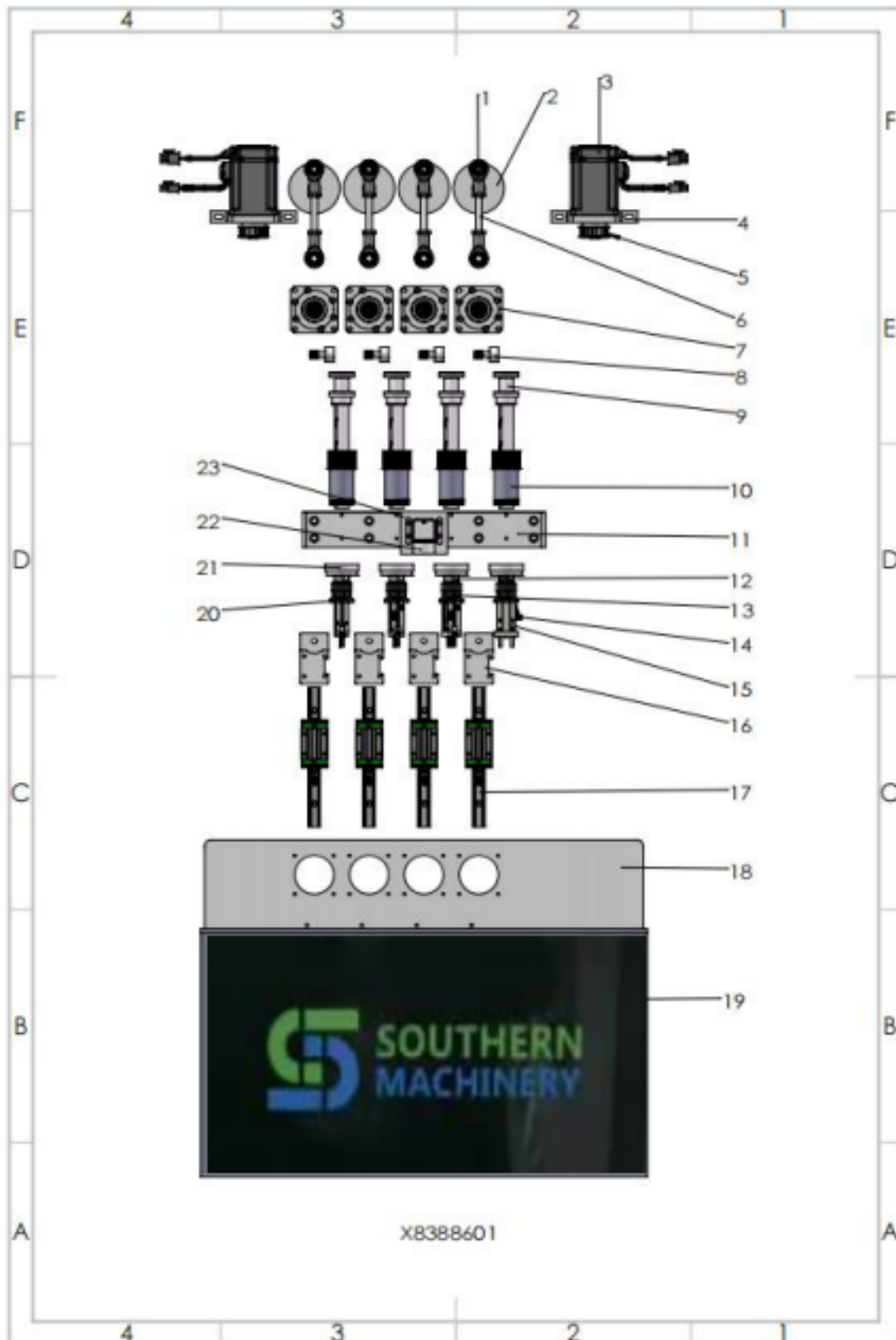

**S7020T Terminal Insertion Machine Use's Manual**

NO.	P/N	Description
1	X8388601-001	Disc handle
2	X8388601-002	Disc
3	X8388601-003	Head 400W motor
4	X8388601-004	Head steering motor seat
5	X8388601-005	400W motor synchronous wheel
6	X8388601-006	8MM screw
7	X8388601-007	Reducer
8	X8388601-008	CF8
9	X8388601-009	CF8 main rod connector
10	X8388601-010	Main shaft synchronous wheel
11	X8388601-011	Cylinder fixing table
12	X8388601-012	Connecting column
13	X8388601-013	ER16A nut
14	X8388601-014	M3 nozzle
15	X8388601-015	Gripper
16	X8388601-016	Bearing seat with handle
17	X8388601-017	Slide rails
18	X8388601-018	Head part plate
19	X8388601-019	Head part safety cover
20	X8388601-020	Finger Cylinder Joint
21	X8388601-021	Head part round connection block
22	X8388601-022	Camera
23	X8388601-023	Camera base

## 8.2 Clinching base part

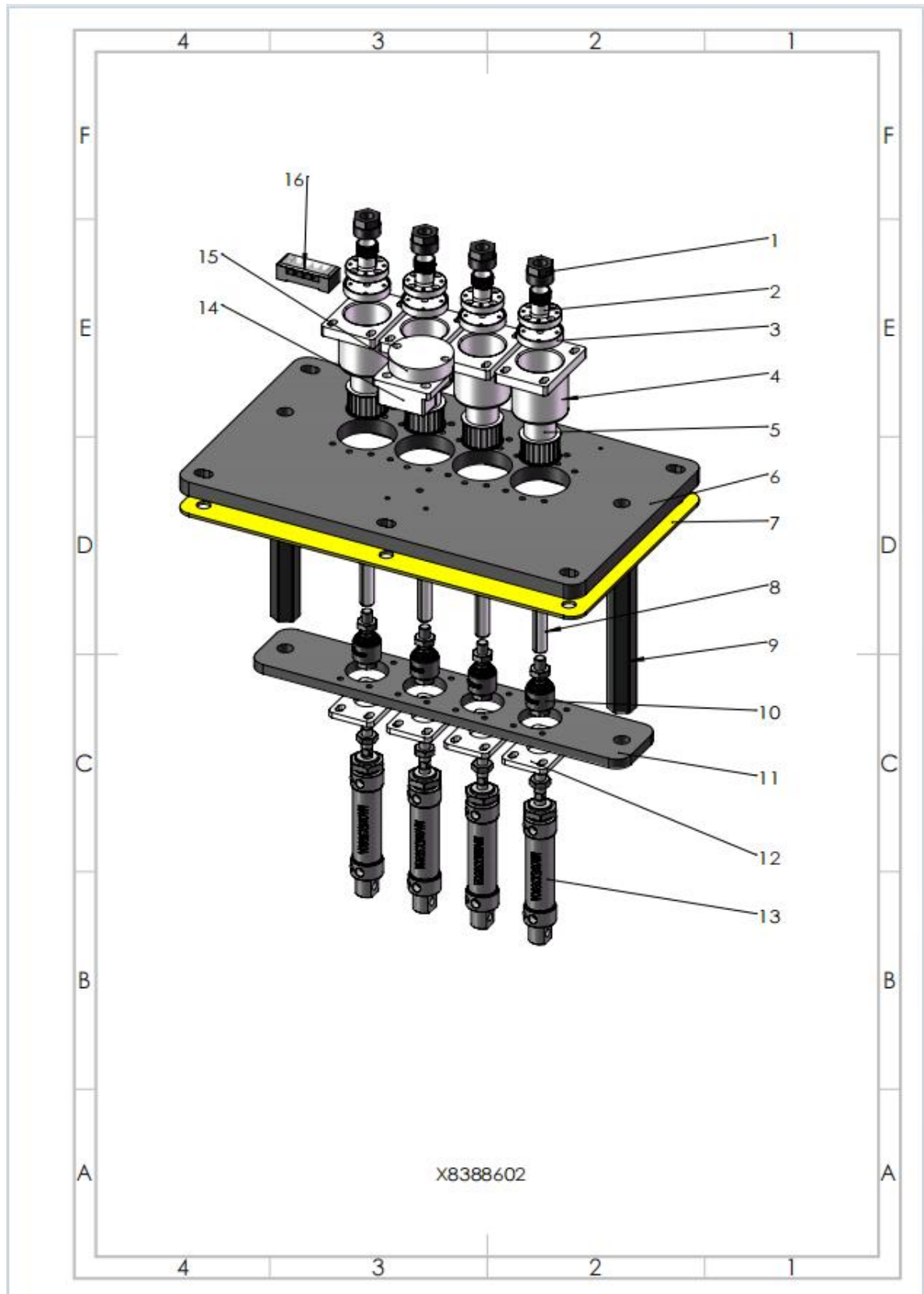

## S7020T Terminal Insertion Machine Use's Manual

NO.	P/N	Description
1	X8388602-001	ER16A nut
2	X8388602-002	Connecting column
3	X8388602-003	Round connection block( $\phi$ 13)
4	X8388602-004	Base cylinder connecting plate
5	X8388602-005	Bearing sleeve
6	X8388602-006	Base upper plate
7	X8388602-007	Base insulation plate
8	X8388602-008	Cylinder bearing rod
9	X8388602-009	Hexagonal connecting column
10	X8388602-010	Floating joint
11	X8388602-011	Base lower plate
12	X8388602-012	Flange
13	X8388602-013	Base cylinder
14	X8388602-014	Backlight base
15	X8388602-015	Camera lamp cover
16	X8388602-016	Detection wire box

## 8.3 Worktable part

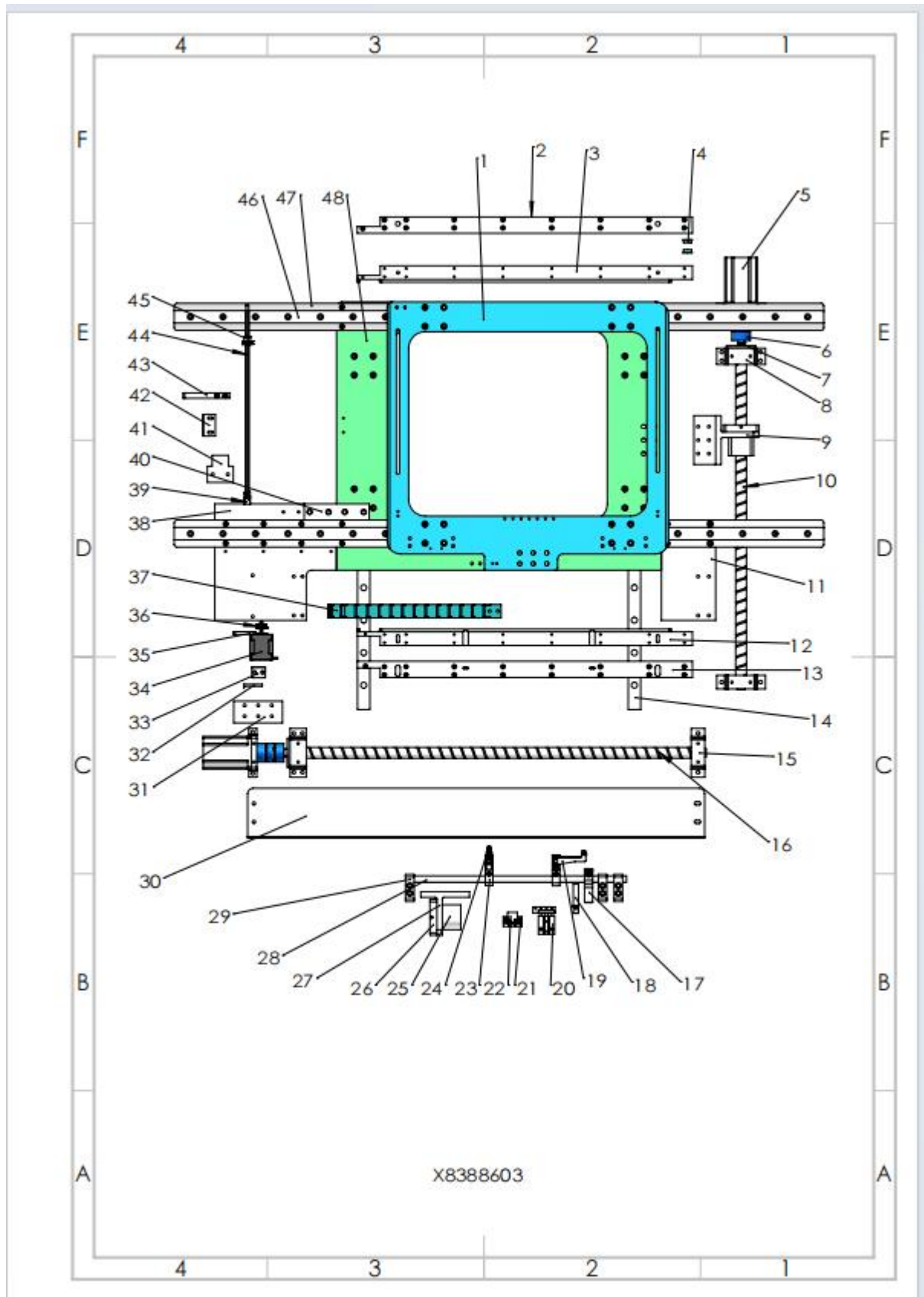

## S7020T Terminal Insertion Machine Use's Manual

NO.	P/N	Description
1	X8388603-001	X-axis moving plate
2	X8388603-002	Workbench upper track B
3	X8388603-003	Workbench lower track B
4	X8388603-004	Belt bearings
5	X8388603-005	400W AC servo motor
6	X8388603-006	Couplings 14*12mm
7	X8388603-007	Screw bearing cap
8	X8388603-008	XY axis screw seat A
9	X8388603-009	Y-axis screw connection block A
10	X8388603-010	Y-axis 660 standard screw
11	X8388603-011	X-axis screw support plate
12	X8388603-012	Workbench lower track A
13	X8388603-013	Workbench upper track A
14	X8388603-014	Y-axis guide rail
15	X8388603-015	XY axis screw seat B
16	X8388603-016	X-axis screw 800mm
17	X8388603-017	Pressure plate cylinder connecting rod
18	X8388603-018	Baffle plate
19	X8388603-019	Z-type splint
20	X8388603-020	Baffle cylinder
21	X8388603-021	Pressed plate cylinder
22	X8388603-022	Cylinder connector
23	X8388603-023	PCB positioning parts
24	X8388603-024	Positioning clip
25	X8388603-025	Screw nut
26	X8388603-026	Screw nut seat
27	X8388603-027	X-axis screw connection block B
28	X8388603-028	12mm axis
29	X8388603-029	12mm axis fixing seat
30	X8388603-030	X-axis screw protection cover
31	X8388603-031	XY axis screw connection block
32	X8388603-032	Pressure plate cylinder gasket
33	X8388603-033	X-axis limit shading sheet
34	X8388603-034	Overboard motor
35	X8388603-035	Track 42 stepper motor seat
36	X8388603-036	Fixed side pulley 19*17
37	X8388603-037	Drag chains
38	X8388603-038	X-axis motor support plate
39	X8388603-039	Universal joint
40	X8388603-040	Motor plate connection block
41	X8388603-041	Y-axis drag chain connecting plate

## S7020T Terminal Insertion Machine Use's Manual

42	X8388603-042	Y-axis shading sheet
43	X8388603-043	Hexagonal bearings
44	X8388603-044	Hexagonal bearing connecting rod
45	X8388603-045	Active side pulley 19*17
46	X8388603-046	X-axis guide rail
47	X8388603-047	X-axis guide rail base
48	X8388603-048	Y-axis working plate

8.4 Conveyor part

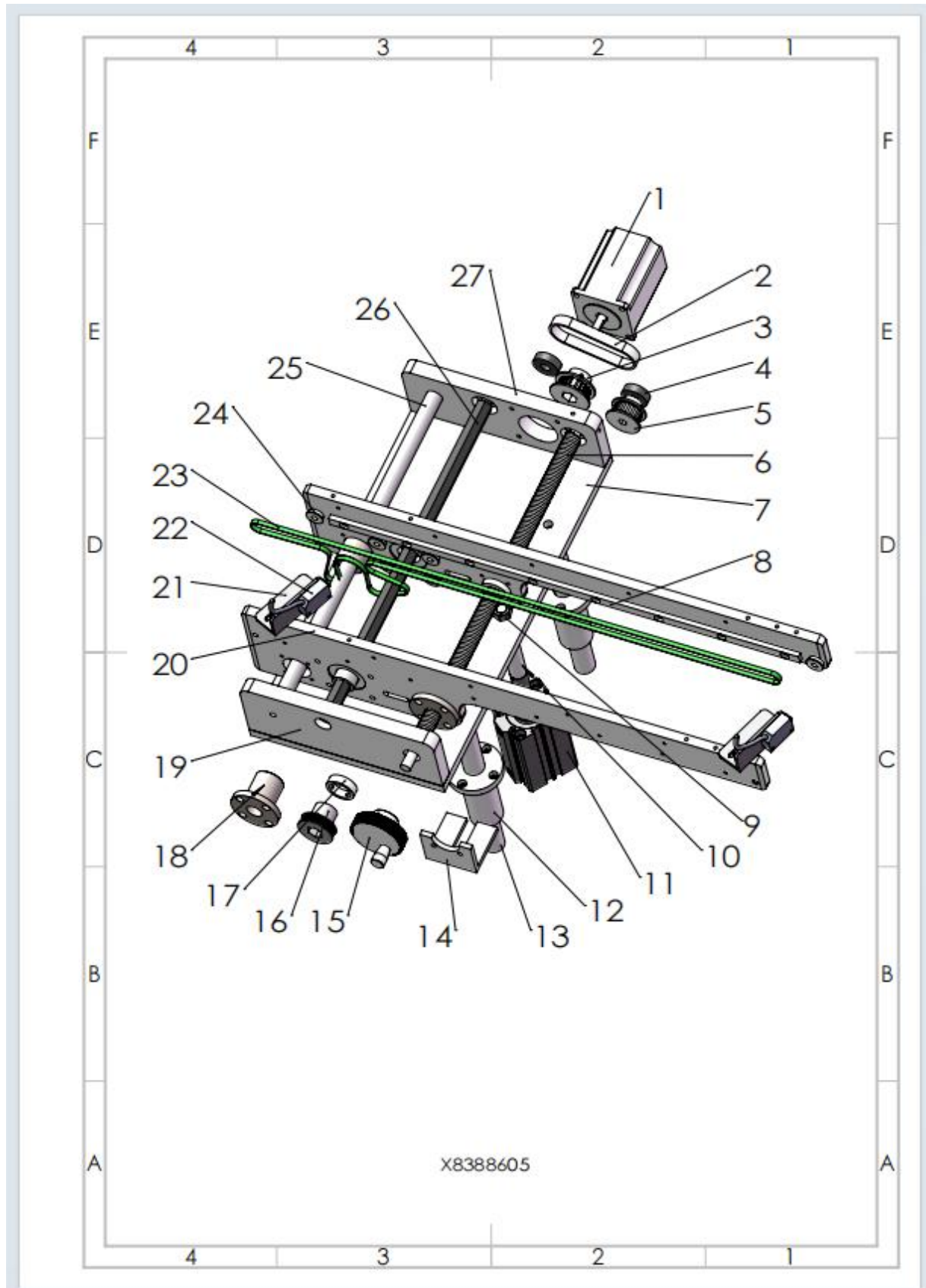

## S7020T Terminal Insertion Machine Use's Manual

NO.	P/N	Description
1	X8388605-001	Motor
2	X8388605-002	Motor belt
3	X8388605-003	Hexagonal column connecting pulley
4	X8388605-004	Ball bearings
5	X8388605-005	Pulley
6	X8388605-006	Screw rod
7	X8388605-007	Conveyor sub-plate
8	X8388605-008	PCB track plate
9	X8388605-009	Hexagonal nut
10	X8388605-010	Cylinder 40-50 extension rod
11	X8388605-011	Conveyor cylinder
12	X8388605-012	Connecting sleeve
13	X8388605-013	Positioning axis
14	X8388605-014	Conveyor plate support
15	X8388605-015	Conveyor handle
16	X8388605-016	Conveyor pulley
17	X8388605-017	Conveyor pulley locking ring
18	X8388605-018	Shaft sleeve
19	X8388605-019	Left conveyor belt outer plate
20	X8388605-020	Transmission Plate
21	X8388605-021	Sensor seat
22	X8388605-022	Panasonic Photoelectric Sensor
23	X8388605-023	Conveyor belt
24	X8388605-024	Edge bearings
25	X8388605-025	Smooth shaft
26	X8388605-026	Hexagonal shaft
27	X8388605-027	Left conveyor side panel

## 8.5 Feeding part

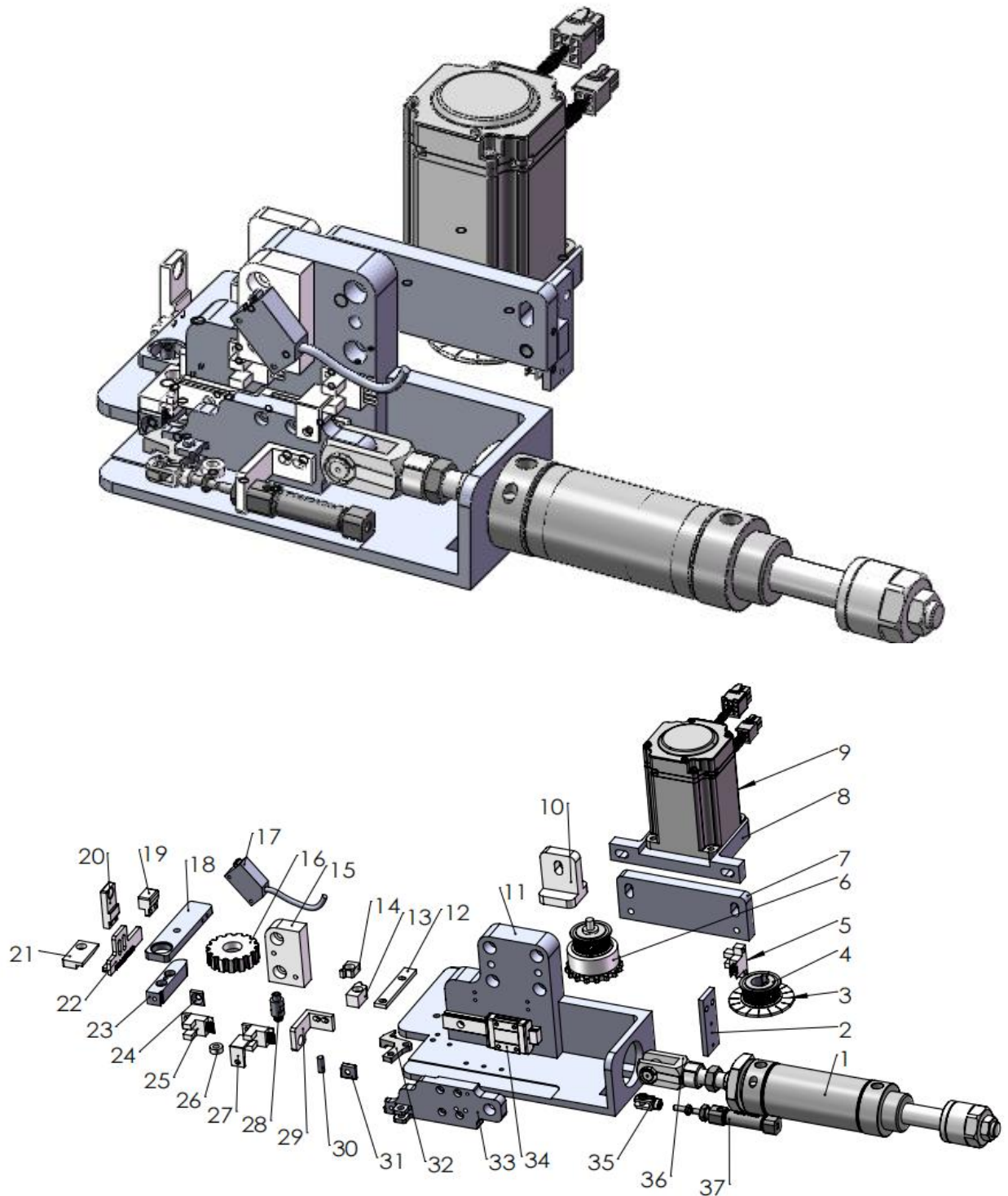

## S7020T Terminal Insertion Machine Use's Manual

NO.	P/N	Description
1	X8388604-001	Cylinder(MACJ40*40-10S)
2	X8388604-002	671 seat
3	X8388604-003	Feeding shading sheet
4	X8388604-004	Synchronous wheel
5	X8388604-005	671 Sensor
6	X8388604-006	Feeding gear 7.92mm
7	X8388604-007	Feed motor fixing block
8	X8388604-008	Head steering motor seat
9	X8388604-009	Feeding motor
10	X8388604-010	Feeding wheel seat
11	X8388604-011	Tape saddle seat
12	X8388604-012	Stop material blocks
13	X8388604-013	Material guide rail
14	X8388604-014	Calibration block
15	X8388604-015	441 sensor seat
16	X8388604-016	Stainless steel pressing wheel
17	X8388604-017	Panasonic Photoelectric Sensor
18	X8388604-018	Press wheel swing block
19	X8388604-019	Spring block 1
20	X8388604-020	Spring block 2
21	X8388604-021	14mm outlet pressure block
22	X8388604-022	Press block
23	X8388604-023	Fixed blade seat
24	X8388604-024	Fixed blade
25	X8388604-025	674 Sensor
26	X8388604-026	Limit bearing
27	X8388604-027	Feeding cutting piece
28	X8388604-028	Press wheel column
29	X8388604-029	Material clamp cylinder fixing seat
30	X8388604-030	Door latch
31	X8388604-031	Movable blade
32	X8388604-032	Blocks for clamping materials
33	X8388604-033	Push material block
34	X8388604-034	Feeding guide rail
35	X8388604-035	Floating joint(F-M4*070Y)
36	X8388604-036	Floating joint(F-MA25Y)
37	X8388604-037	Cylinder(PB10*10SR)