



3000 Series

Model	3000 Series
Dimension (mm)	1700 (L) × 1500 (W) × 1600 (H)
Top speed	20,000 points/hour (Theoretical velocity) 10,000 points/hour (Actual velocity)
Available PCB Size (mm)	50(L) *50(W) - 400(L) *300(W)
PCB Thickness (mm)	0.79-2.36mm
Component types	2.5/3.5/5.0/7.5/10.0mm, three combinations.
Component specifications	Maximum height is 20mm, maximum diameter is 13mm, maximum pin diameter is 0.7mm
Component lead trimming length	1.5±0.3mm (short blade), 2.0±0.3mm (long blade)
Component lead bend angle	10-15 degrees (adjustable)
Number of Feeders	10 stations (recommended number of stations)
Air Source	0.6--0.8MPA
Power Supply	220V, 50Hz
Net Weight (kg)	880KG

- **Advantages:**

- **Highly Efficient Production:** The machine's high efficiency rate is ideal for mass production, ensuring a high throughput of 18,000 points per hour.
- **Versatile PCB Handling:** Accommodates a wide range of PCB sizes and thicknesses, making it suitable for various types of electronic boards.
- **Diverse Component Compatibility:** The ability to handle multiple component sizes and specifications allows for flexibility in production.
- **Precision in Component Processing:** Adjustable component lead trimming lengths and bend angles ensure precise placement and fitting.
- **Optimized Feeder Stations:** The recommended number of feeder stations optimizes the machine's performance and reliability.
- **Sturdy and Robust Design:** A significant net weight of 880 kg contributes to the machine's stability during operation.

- **Benefits:**

- **Increased Productivity:** The machine's high efficiency and speed upgrades can lead to increased productivity and reduced turnaround times.
- **Flexibility in Manufacturing:** The range of PCB sizes and component types that can be handled by the machine allows for greater flexibility in manufacturing different products.
- **Quality Assurance:** Precision settings for component processing contribute to consistent quality in the final product.
- **Ease of Use:** The machine's design considers ease of operation, with adjustable settings to accommodate various production requirements.



3000 Series



1.5 KW head-driven motor

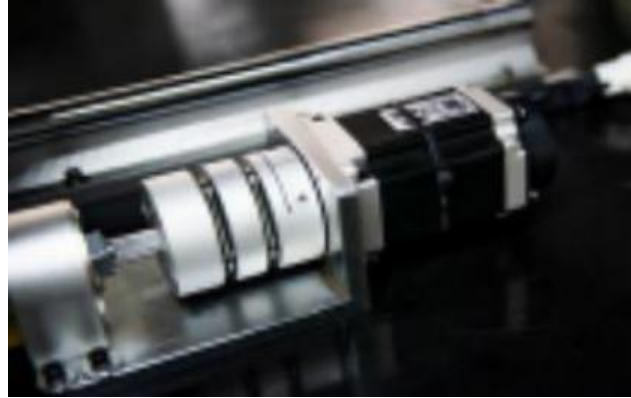

400W X-Y table mot



7 sets servo system



**SOUTHERN
MACHINERY**

3000 Series Radial Machine



Quad-span support :

2.5/5.0/7.5/10.0 mm span component can be insert at the same time

Customized: 12.5/15mm Lead Span

3000 Series Radial Machine



**LED Signage / LED
Illumination**



**LED Drivers /
Fluorescent Ballasts**



**Set-top Box / Game /
Motherboard**



**Appliance (White
Goods)**



Power Conversion



High-Mix Environments



Connectors	Transistors	Tabs/Clips	E-Caps	Resistors	Adjustable Resistors	Capacitors	Veristors/ MOVs	LEDs
								
								
								

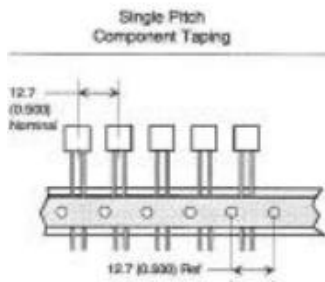

Component Spacing for 12.7 (0.500) Pitch Tape

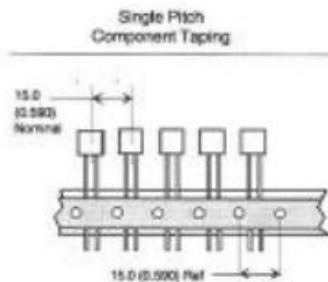
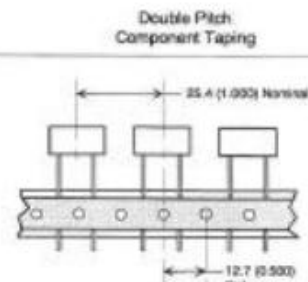

Component Spacing for 15.0 (0.593) Pitch Tape

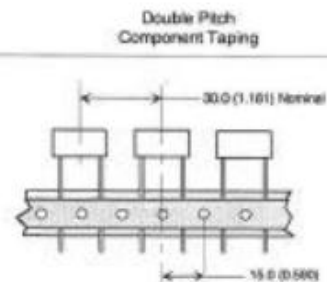

4000 Series Radial Machine



Item	Specifications
Circuit board transportation method	Online type, automatic loading and unloading; from left to right, or right to left; customized manual version.
Drive System	Customized absolute servo drive eliminates the need for dozens of photoelectric switches.
Control System	Bus type, multi-axis control.
operating system	Chinese/English operation interface (WINDOWS7 system control platform).
Data entry method	USB interface input (EXCEL document format).
smart factory	4G Internet of Things, compatible with MES system, "black box".
Number of feeders	Stops 10/20/30/40. (Configuration on demand)
Machine size (length*width*height, unit: mm.)	Main machine: 1780*1500*1600; Auxiliary machine: 500*900*1000; Material station (10 stations): 850*900*1360; Material station (20 stations): 1400*900*1360.
Machine weight	Host weight (standard version): 850KG
using electric	Single phase, AC, 220V, 50/60HZ, 1.6KW. (L+N+E)
System protection	Isolation transformer and other multiple protections.
Use air pressure	0.5--0.7MPA
Gas consumption	0.3 cubic meters/minute
Use ambient temperature	5-28 degrees Celsius
Machine noise	65-75 decibels

4000 Series

4000 Series Radial Machine

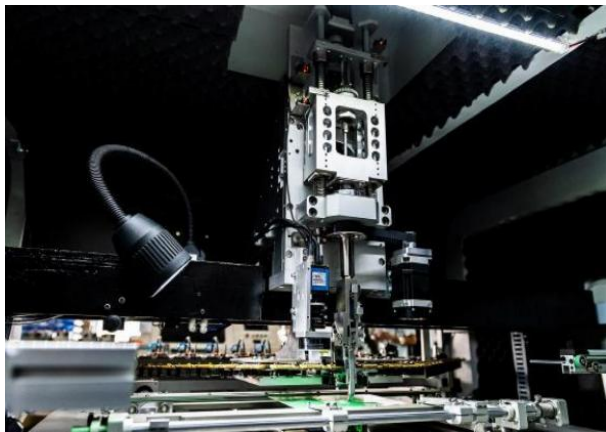

Item	Specifications
Top speed	20,000 points/hour (Theoretical velocity) 10,000 points/hour (Actual velocity)
Insertion defective rate	Less than 500PPM
Substrate size	The minimum is 50mm*50mm, the maximum is 330mm*300mm. Can be customized as needed.
Substrate thickness	0.79-2.36mm
insertion angle	any angle
component span	5.0-22mm
Component type	Horizontal tape packaging materials for diodes, resistors, etc., barrel jumpers.
Can pass component height	15mm. Can be customized as needed.
Jumper (JW)	Diameter 0.3mm-0.8mm tinned copper wire. Independent delivery of barrel jumpers.
Component lead trimming length	1.2-2.2mm(adjustable)
Component lead bend angle	0-35 degrees (adjustable)
Plug-in editor	Available online or offline. Quick online editing of puzzle programs.
Hole position correction method	Machine vision automatic correction, multi-point MARK correction.

4000 Series

- **Advantages:**

- Efficiency: High-speed operation and low defect rate enhance production efficiency.
- Customization: The machine's adaptability to various PCB sizes and components allows for tailored production processes.
- Precision: Multi-axis control and machine vision correction ensure high precision in component placement.
- Integration: Ready for smart factory settings, facilitating seamless integration into modern production lines.
- User-Friendly: Intuitive dual-language operating system and easy data entry method streamline the user experience.

- **Benefits:**

- Increased Productivity: The machine's high speed and efficiency lead to increased productivity and reduced downtime.
- Flexibility: The ability to handle a diverse range of components and PCBs allows for flexible manufacturing options.
- Quality Assurance: Precision controls and low defect rates contribute to consistent product quality.
- Future-Proof: Smart factory compatibility ensures the machine remains relevant as technology advances.



4000 Series

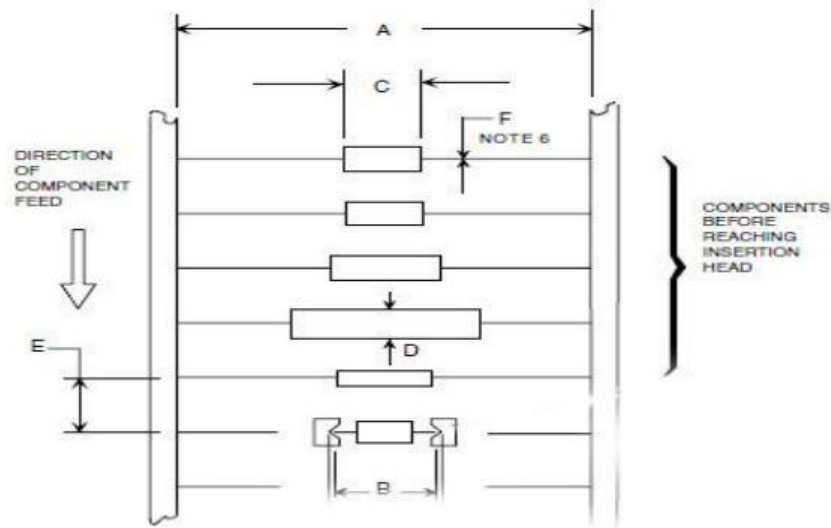

Hole Span: 5~20mm
JW Span: 5~30mm

Hole Diameter = Lead Diameter + 0.48mm \pm 0.08mm.
(0.019") (0.003")

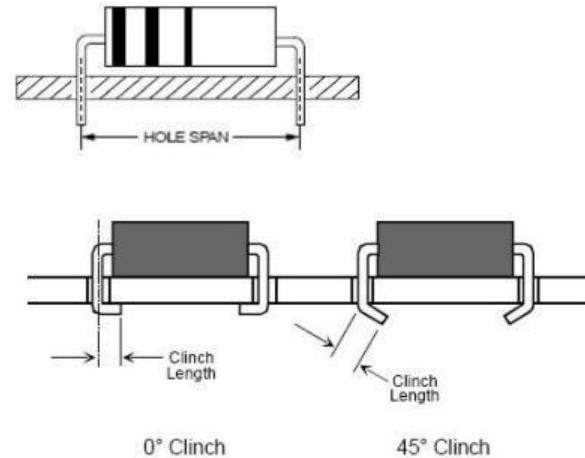

Clinch lead angle is adjustable in a range (0° - 45°).

Clinch lead length is adjustable from 1.28mm (0.050") to 1.80mm (0.071").

And is measured from the center of the insertion hole to the end of the lead.



Insertion head work principal

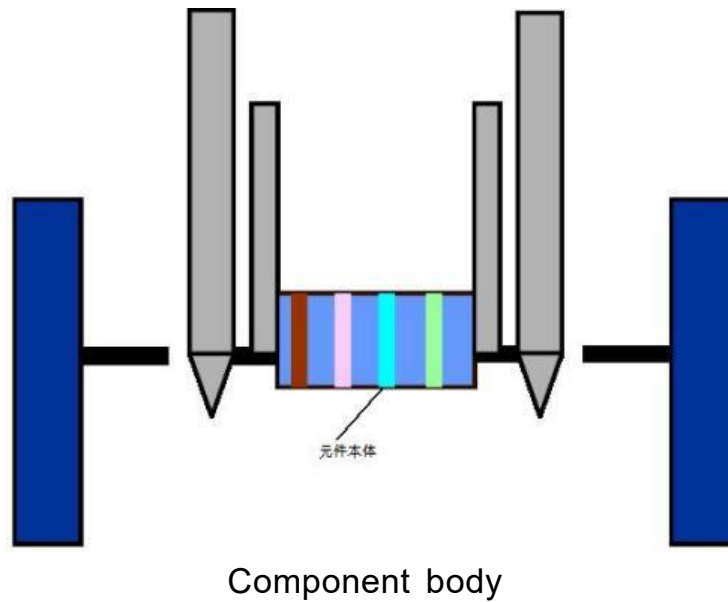

Best After-sales service

- **Worldwide Support**
- **Free Installation/
Training**
- **1 day lead-time (spare
parts)**
- **1 Month customize
solution**



Welcome inquiry

1. Please visit : www.smthelp.com
2. Find us more: <https://www.facebook.com/autoinsertion>
3. Know more our team: <https://cn.linkedin.com/in/smtsupplier>
4. Welcome to our factory in Shenzhen China
5. Google: Automatic Insertion Machine
6. Looking forward to your email: info@smthelp.com