

Manual

S-700 Outside type vacuum sealing machine



Shenzhen Southern Machinery Sales and Service Co., Ltd

Add:Room 1806 Block 3 Jinyun COFCO,Qianjin 2nd Road,
Xixiang, Baoan District, Shenzhen ,China

Email: chan@smthelp.com

Mobile: +8615012477357

Catalog

1 overview -----	3
2 Safety precautions -----	4
3 Main parts and related parameters-----	7
4 Preparation before set the machine-----	9
5 Correct use method -----	9
Basic operation	
Various operation modes using method	
6 Equipment maintenance -----	12
7 Common trouble shooting method -----	15
8 Specifications -----	17
9 Warranty notice -----	17

1 Overview

Thank you very much for your support, because of your right choice, so you have a safe, practical, efficient and innovative external pumping type vacuum packaging machine.

This machine is an external vacuum packaging machine for vacuum and gas filling and sealing of food, medicine, native products, electronic components, instrument components, clothing and so on. The machine is the biggest feature is not limited by the size and size of the packing, any vacuum or nitrogen filling (or other gas) packaging. Adapt to a wide range of economic benefits, the use is very convenient.

This machine suitable packaging material for various composite films such as polyester / polyethylene, nylon / polyethylene, polypropylene / polyethylene, polyester / foil / PE, nylon / aluminum foil / PE and other composite materials.

This machine packaging items with mildewing and anti moth, anti pollution, anti oxidation, province volume, save freight cost and prolong storage period, to ensure the quality of goods. The machine has the advantages of compact structure, small size, light weight, low power consumption, high sensitivity, convenient operation and maintenance, etc..

The machine is mainly composed of fuselage, electrical system, pneumatic system, vacuum system, four parts composition, working process can be controlled automatically by the computer board, heat sealing temperature and packaging items required for the vacuum degree can be adjusted is currently pumping type vacuum packaging machine can not be replaced by a new type of vacuum packaging machine.

2 safety precautions

Must use the power socket with equal capacitance machine.

Power plug should be inserted into the socket directly and stably.

DANGER! The capacity of the machine varies depending on the size of the machine. It is necessary to determine the electrical capacity of the socket is greater than the capacity of the machine that you are using, and to insert the plug into the. Use of smaller capacity of the socket or the extension of the line, the line will cause damage or cause fire, be sure to use the appropriate socket.

No waterproof function of the machine, can not use this machine for sealing liquid, do not clutch is arranged in the wet ground.

Do not use this machine in a highly humid environment, do not allow the machine to access a large amount of water vapor.

In a dusty place, do not use or place the machine.

Use the machine for liquid sealing or be poured water, will cause damage to the machine or electric shock.

The use of this machine, or exposure to a large amount of water vapor in a highly humid environment, may cause rust and lack of insulation, which may cause the machine to stop, short circuit or electric shock.

Will not put his hand into the sealing part.

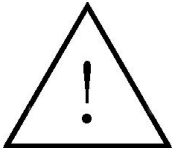

Be careful

Sealing parts after long time operation to maintain a high temperature, the hands can cause burns, can not put their hands.

Be careful

Two person operation will increase the likelihood that the finger is touched, please be more careful.

Don't metal materials into sealing parts.

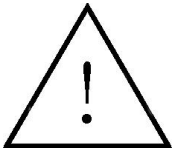

Be careful

Before using this machine, it should be realized that the wire short circuit will be put away electric shock or fire, causing the machine to stop, in the cause of the accident to identify and repair the completion of the completion of the machine, do not use this machine.

Machine use will make the general wear parts deal with them regularly, and make the appropriate maintenance schedule. When changing any parts, please refer to the "manual", "can replace parts" page, according to the steps to correct.

Before changing any parts, be sure to pull out the power plug.



Be careful

Please follow the instructions in this manual to maintain the proper way. Replace any part, you have to unplug the power plug, or you may get an electric shock. If you don't have the permission of your engineers, please don't change your machine. We will not take any responsibility for any downtime or any accidents due to your changes.

Read the instructions carefully and correctly use the machine.

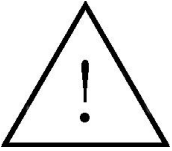

Be careful

We do not press the requirements of this specification, improper operation caused by downtime or any accident, do not bear any responsibility.

3 Main parts and related parameters

*The main external part name

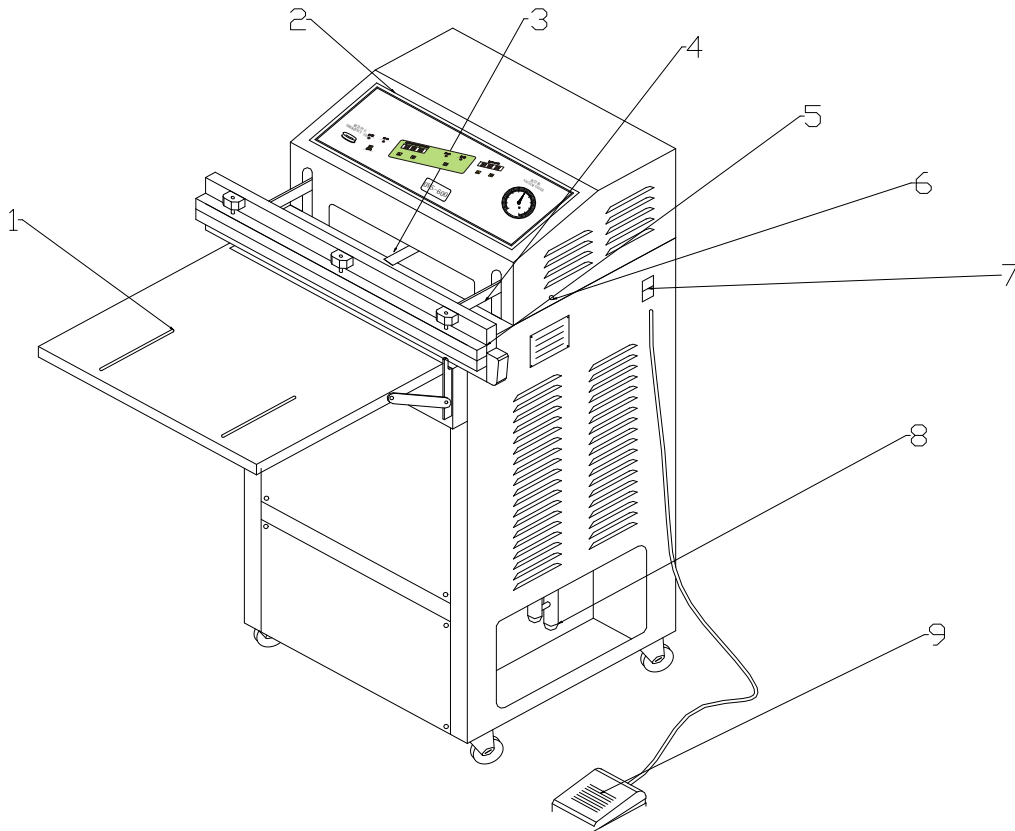

- (1) support table
- (2) control panel
- (3) gas nozzle
- (4) pressure bar
- (5) sealing cutting knife
- (6) fixed screw
- (7) power switch
- (8) air filter
- (9) foot switch

*Control panel

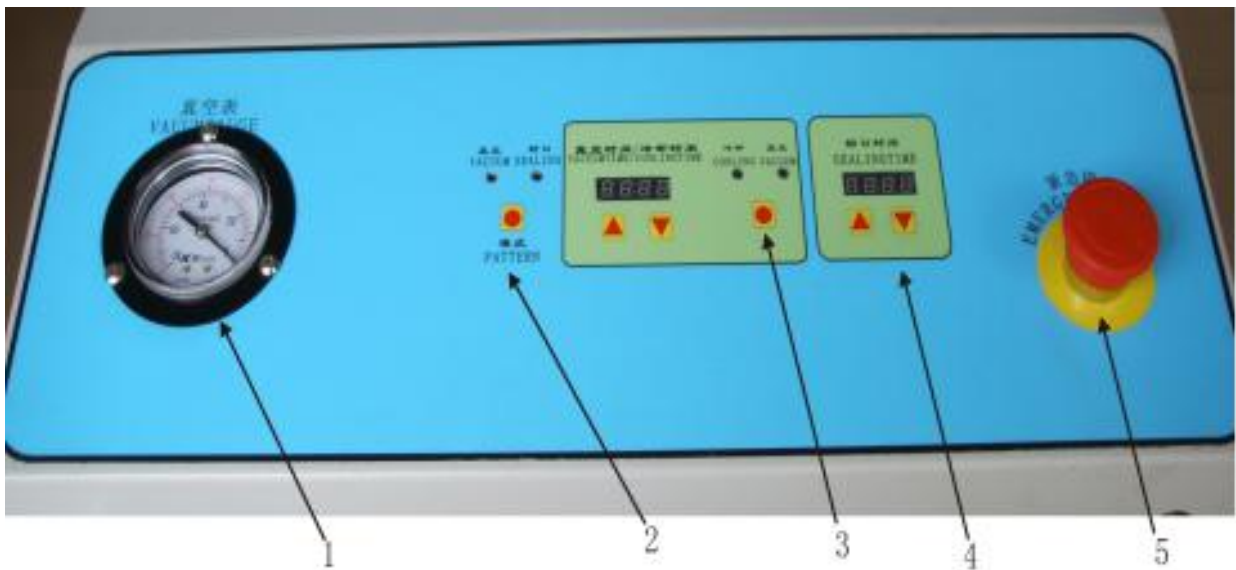

1) vacuum gauge -----vacuum packaging object developing test

2) switching time setting switch----- switch switch can be set to developing this cooling time, vacuum time, aeration time,

Cooling time: when the lamp 1 bright for the cooling time, through the left and the button can be set

Vacuum time: when the lamp 2 at the same time as the vacuum time, through the left and the button can be set

Inflation time: when the lamp 2, 1 at the same time as the inflation time, through the left and the button can be set

3) work mode switch ---vacuum mode ,sealing mode, inflatable mode

Vacuum mode: when the vacuum lamp is vacuum mode

Sealing mode: when the sealing light as the sealing mode

Inflatable mode: when the vacuum lamp, sealing lamp and light at the same time as the charging mode

4) Heating time --- developing regulation sealing knife

5)Emergency stop switch ---when developing an emergency, stop the machine

4 Preparation before set the machine

Machine stable set in safe working position.

In order to work safety, the machine is set to the appropriate place, and the work table and the host safely placed in a flat place, connecting wires and ventilation pipes should be firmly connected to the ground.

DANGER! Do not use the machine in inclined, uneven or unstable place, otherwise, the machine may fall and damage or cause damage to personnel. Should be in a stable, flat plane to use the machine, if placed heavy or strong extrusion table, may cause unforeseen accidents.

DANGER! Don't use machines on wetlands. Do not let the machine hit water droplets or steam, or may cause downtime and short circuit.

5 Correct use method

Basic operation

- (1) insert the plug directly into the socket
- (2) turn on the power switch
- (3) the emergency stop button

Check whether the red indicator light is on.

When you have finished checking, it becomes a standby state.

Standby state: the pressure bar is located at the top, the gas nozzle is located in the rear.

- (4) According to the material and the thickness of the selected pockets to set the time for sealing and cooling.
- (5) According to the size of your needs or pocket, set the vacuum time.
- (6) Choose one of the following three modes: sealing, vacuum, charging.

Reset and power off

- (1) press the emergency stop button or turn off the power switch.
- (2) check the sealing parts and clean the machine.

Various operation modes using method

Sealing mode

Determine sealing mode in mode selection switch

- (1) according to the material and thickness of the pocket, the heating and cooling time are set.
- (2) place the pocket in the sealing position, tighten the pockets on both sides, do not produce wrinkles.
- (3) to move the foot pedal switch, the cylinder starts to work for the first time, only uses the adhesive strip to press the film bag.
- (4) to move a foot switch, second cylinder, pressure bar will be completely compression bag.
- (5) heating and cooling will work, when the seal is completed, the pressure bar will automatically open. Pressure bar in the seal after the completion of the move up The pressure lever moves up and takes the bag.

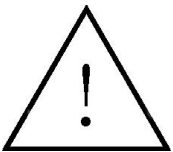

Be careful

For the sake of safety, this machine is a gas nozzle forward set delay time, please be careful!.

Vacuum mode

In mode selection to determine the mode conversion in vacuum

Seize the outward pocket, do not squeeze objects near the gas nozzle.

(1) set the heating and cooling time according to the material and the thickness of the pocket.

(2) setting the vacuum time according to the volume of the package.

(3) plug the pocket into the gas nozzle, adjust the ends of the pocket and align the sealing line.

(4) the first point of the foot switch

The cylinder will hold the bag drop

(5) let the object close to the air nozzle (to achieve a good vacuum)

(6) second point switch

Vacuum will be set at the time to start and run.

Vacuum will be set at the time of operation, when the vacuum is completed, the gas nozzle will be moved after the heat seal.

(7) timing vacuum and sealing finish

Pressure bar in the seal after the completion of the move up

The pressure lever moves up and takes the bag.

Time adjustment

The first time setting

Time rotation pointer for heating, cooling and vacuum.

(1) adjust the sealing timer

For each pocket thickness and material set different time, you should confirm the sealing requirements.

Normally set to only 100, if you set the time than the need for sealing, will result in dislocation and sealing condition of the melt.

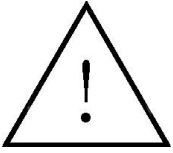

Be careful

Do not arbitrarily change the heating time, set more than the required time may cause overheating after damage to the machine. (note, note)

(2) cooling timing adjustment

For each pocket thickness and material set different time, you should confirm the sealing requirements, usually set to 3 seconds.

(3) vacuum timing adjustment

For packaging and processing requirements of the situation, there are different time settings, to confirm the time required to achieve a vacuum.

6 Equipment maintenance



Be careful

When you open the lid, be careful not to be hurt by its side.

Clean air filter

An air nozzle filter between the gas nozzle and the exhaust pump, which may contain a number of foreign bodies (a small amount of liquid, powder and particles) that have fallen into the lid, and the lid is checked and cleaned every day.

Removed the lid

If the liquid infiltration in the machine too much, they will overflow filter, fell into the vacuum pump, it will damage vacuum pump to prevent liquid from entering the vacuum pump.

Clean out the air filter of entrance and exit

Vacuum pump air through air filter smoke outside, if are left with dust and dirt in the lid, vacuum pump effect is not ideal. Therefore, a week cleaning air filter cover a.

Clean air tube

If you push the pipe at the same time, you can easily take down the pipe.

Replace Teflon sheet

When the Teflon sheet loss, burned or defaced when sealing

(1) four fixed screw loose Teflon frame

(2) now you can rotate the Teflon rotary rod, will be destroyed after the Teflon sheet or roll forward

When the Teflon sheet bonded to the heating line, it will be cut off before the scroll (20-25 mm Teflon sheet roll a circle).

For heating plate

If the heating plate is burned, defaced or uneven sealing, please replace the heating plate

(1) under heating in Teflon, remove the Teflon film.

(2) the electrode cover is fixed on the side, with a screwdriver to screw and then relax, take the lid off.

(3) the electrode rod lift, relax the heating piece, with a screwdriver to screw loosening.

Installed heating plate

The heating sheet is arranged in the electrode rod, finger according to the tight heating sheet port at the same time, with screws and tighten screws so that it can not slide out of the chuck.

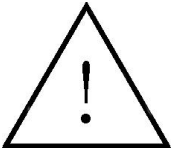

Be careful

If the damaged Teflon or invalid, please replace the Teflon tape

Replacing tape and Teflon sheet

If the heating piece of tape or Teflon sheet burned, the line heating itself may short-circuit and melting and lead to sealing is poor, must be timely inspection, and replace them if necessary.

(1) for the Teflon plate and heating plate

(2) the tape and Teflon sheet heating plate under completely eliminate

(3) according to the length of the heating part, plus a new Teflon sheet.

(4) with a piece of adhesive tape on the special fluoride film, adhesive tape must be 5 cm longer than the sealing part.

(5) sticky tape residual, will have the opposite effect on the sealing surface, please fully clean up on the surface of adhesive tape and teflon film before.

7 Common trouble shooting method

Problem	Reason	Solution
Sealing is not ideal	Heating blade, Teflon or silicone dirty	Wipe with a cloth
	Teflon sheet damaged	Replace Teflon sheet
	Silica gel damage	Replace or clean up
	Tape damage	Replace adhesive tape
	Cooling time is too short	In the heating lights, adjust pointer few seconds <u>cooldown</u>
Seal is not smooth	Impaired or uneven use of silica gel	Replace or use the reverse side
The heating blade often breaks	Too long heating time	Will be able to seal the pointer to the shortest heating time
	Too short cooling time	In the heating lights, adjust pointer few seconds <u>cooldown</u>
	Tape damage	Change tape
	Failure blade	Replace heating blade
While the heating light is bright, the blade is not heated.	Heating blade breakage	Replace heating blade
	Failure solid state relay	Contact us or our dealer for replacement.
Although the vacuum began, but the air was not discharged from the pocket	The gas nozzle is not in the pocket.	Power off and restart
	Vacuum bag barrier	Let the object close to the gas nozzle for easy
	The gas nozzle or dirty filter	Clear air nozzles and filters
Although the power light is bright, and the pressure over the foot switch, but the pressure is not down	Foot switch failure	Remove foot switch, measuring the resistance profile of the universal meter. When it is pressed down, the resistance is very small, and the resistance is close to 0.

<p>Press the foot switch, the pressure lever down, but after the release of the foot switch, the pressure lever immediately move up</p>	<p>The upper sensor is misplaced in the cylinder.</p>	<p>Check whether the signal is bright (105)</p>
	<p>Back to the gas nozzle sensor, in the sealing action in the wrong position</p>	<p>Check whether the signal is bright</p>
	<p>Push forward gas nozzle sensor fault in the vacuum action into the gas nozzle position</p>	<p>When you select a vacuum and step on the pedal switch, the gas nozzle moves forward and checks whether the position signal is light or not.</p>
	<p>The middle position sensor is placed in the cylinder.</p>	<p>When the sponge rod is in contact with the bag and the machine is ready to exhaust, check whether the position signal is bright.</p>
<p>Seal run stop, (the heating lamp does not continue to light)</p>	<p>Start the sensor fault in the cylinder position</p>	<p>When heating begins, check whether the position signal is bright.</p>

8 Specifications

Model	S-700
Production capacity	3 ~ 10(bag/min)
Sealing leangth(mm)	W700 max
Max package size(mm)	L(no limit)×W700×H(no limit)
Power Supply(V)	single phase,220V 50Hz
Total(Kw/h)	1.8Kw/h
Ultimate vacuum(KPa)	0.2KPa
Dimension(mm)	L770×W460×H1050
Net weight(kg)	70kg

9 Warranty notice

1 vacuum pump oil

Vacuum pump should be used in accordance with the provisions of the SH0528-92 standard vacuum pump oil. Ambient temperature of 0 degrees Celsius to 10 degrees Celsius, the use of ISO-VG32 viscosity grade vacuum pump oil. Vacuum pump oil with ISO-BG100 viscosity grade at ambient temperature at 10 C to 40 C.

Vacuum pump must ensure that the level in the oil window height of 1 / 2 a little higher, should always check the oil level and oil pollution, the proposed operation of 50 to 100 hours of maintenance oil change time according to the maintenance.

Oil contaminated black, emulsion or thickening oil should be promptly. The oil and oil filter should be replaced. Clean the pump before adding the new oil.

Cleaning and changing steps:

1. The power supply is cut off, the pump in the hot state, spin open oil plug, the dirty oil drain.
2. Oil drain plug on the spin, connected to the power supply, open the pump for 5 seconds to 10 seconds, then stop the pump, screwed open oil plug, the oil drain.
3. 3 rotary oil drain plug, then unclip oil filler plug, into the cleaning oil (No. 32 ordinary machine oil, see the oil window in the oil into the oil window height of 3 / 4, then screw on the oil filler plug.
4. The restart pump car for 5 minutes to 10 minutes, stop the pump.
5. The rotary open oil plug, oil will go.
6. The repeated operation, and the steps of mechanical oil until put out transparent (color like oil)
7. Oil drain plug and screw pump, then 5 seconds to 10 seconds, then turn the open oil plug, oil drain.
8. We put on the drain plug and unscrew the gas plug, adding a new level of vacuum pump oil, the oil window to 3/4

2 replace the exhaust filter

If the pump temperature is significantly increased, the motor current to reach or exceed the rated current, the pump exhaust fumes are generated, you should check the exhaust filter is blocked, such as blocking, should be replaced in a timely manner. An exhaust pressure meter can be installed at the pump filling hole to check whether the filter is blocked, and the exhaust filter can be replaced when the pressure exceeds 0.6bar (table pressure).

3 clean air filter

The suction filter should be kept clean in order to avoid the decrease of air extraction.

Operation: after the pump is stopped, the first suction nozzle connector from the suction nozzle and unscrew, then the suction nozzle four screws loose, remove the air filter,

Put in the washing liquid (diesel or kerosene) wash, then dry the suction nozzle to clean the plane, air filter

A suction nozzle, then the suction nozzle with four screws tightened.

Failure phenomena	Cause of production	<u>Resolvent</u>
Pump can not be started	1 motor wiring is wrong, the voltage is too low 5 pump or motor stuck 6 ambient temperature is lower than 0 C oil viscosity 7 pump card dead	5. Power failure 5 re wiring, check voltage 6 remove the fan cover to test the pump and motor to find out the fault of the pump or motor. 7 before refueling, the oil heated to about 30 8 check whether there is dirt suction mouth
Pump does not reach the required limit pressure	8 there is a condensate or gas in the pump oil 9 measuring method or instrument is not correct 10 there is an external leakage 11 suction valve failure 12 exhaust valve failure 13 pump cavity lack of oil 8. Contamination with wrong oil or oil	8 boxing air intakes run for 60 minutes. 9 use the correct measuring method or instrument 10 check the pump and pipeline connection seal, remove leakage 11 check the suction valve action is flexible, whether the solenoid valve pipeline leak 12 replace the exhaust valve 13 check the oil level, check the oil filter is blocked 8. New vacuum pump oil
Pump pumping rate decreased	3 suction mesh plug 3. Air intake duct is too long or too narrow	3. 3 clean the suction filter Use a thick and short intake pipe
Motor operating current is very large, (close to more than rated current)	3 oil emulsion, thickening 4.Exhaust filter blockage	3 to maintain the machine 3. Replace exhaust filter

<p>Pump oil consumes a large exhaust oil mist droplets</p>	<p>5 pump too much oil 5. exhaust filter installation location is not positive or filter material rupture 7 exhaust filter plug 6. Return valve failure, return pipe blockage</p>	<p>5 put too much oil 6 re install the exhaust filter or replace the exhaust filter 7 replace the exhaust filter 5. Replace oil return valve to clean and return oil pipe</p>
<p>Pump running a large bath</p>	<p>5. The oil level is too low 6 oil filter plug 7 coupling elastic block wear Abnormal wear of blade or pump body</p>	<p>5. 5 plus vacuum pump oil (by standard) 6. 6 replace oil filter 7. 7 replacement coupling elastic block 8. Replacement of worn parts (please replace)</p>

Welcome inquiry

- 1, Please visit : www.smthelp.com
- 2, Find us more: <https://www.facebook.com/autoinsertion>
- 3, Know more our team: <https://cn.linkedin.com/in/smtsupplier>
- 4, Welcome to our factory in Shenzhen China
- 5, Google: Auto+Insertion
- 6, Looking forward to your email: chan@smthelp.com